

ECOMPACT 190

ECOMPACT 250

ECOMPACT 270

ECOMPACT 290

ECOMPACT 320

EN

INSTRUCTIONS FOR USE

**Copyright © 2021 KLOVER Srl**

All rights reserved. The reproduction of any part of this manual, in any form, without the explicit written permission of KLOVER S.r.l. is forbidden. The content of this manual may be modified without prior notice. Although the documentation contained in this manual has been carefully compiled and checked, KLOVER S.r.l. cannot be held liable for any damages arising from the use of the same.

**CONTENTS**

CONTENTS .....	1
INTRODUCTION.....	2
IMPORTANT SAFETY INSTRUCTIONS .....	2
THE MACHINE AND THE PELLETS .....	3
COMPONENTS OF THE APPLIANCE .....	3
TECHNICAL SPECIFICATIONS.....	5
TECHNICAL SHEETS FOR DIMENSIONS AND CONNECTIONS .....	5
PELLET PROPERTIES .....	6
REQUIREMENTS OF THE PLACE OF INSTALLATION.....	6
POSITIONING .....	6
SPACES AROUND AND ABOVE THE APPLIANCE .....	7
EXTERNAL AIR INTAKE .....	7
SMOKE DUCTS AND CONNECTION TO THE FLUE.....	7
CHIMNEY .....	9
ELECTRICAL CONNECTION.....	10
CONTROL OF A POSSIBLE THREE-WAY MOTORIZED VALVE FOR DHW SYSTEM MANAGEMENT .....	10
CONNECTION TO THE ROOM THERMOSTAT .....	10
HYDRAULIC CONNECTION .....	11
THE TFT DISPLAY .....	12
THE MENU - TFT DISPLAY .....	13
INITIAL START-UP .....	19
SYSTEM CONFIGURATION.....	19
INITIAL FILLING OF THE SYSTEM .....	22
PELLET LOADING AND CONNECTION TO THE MAINS POWER SUPPLY .....	22
IGNITION CYCLE .....	22
SWITCH-OFF CYCLE.....	23
MODIFYING THE WORKING POWER AND THE TEMPERATURES OF THE ROOM, BOILER WATER, WATER HEATER OR PUFFER – TFT DISPLAY.....	23
PROBLEMS, ALARMS, USEFUL TIPS .....	25
USEFUL INFO.....	25
WHAT HAPPENS IF... .....	25
ALARM SIGNALS .....	26
CLEANING AND MAINTENANCE .....	27
PRECAUTIONS BEFORE CLEANING .....	27
ROUTINE CLEANING .....	27
NON-ROUTINE CLEANING .....	28
CLEANING THE CERAMIC GLASS.....	29
CLEANING THE FLUE .....	29
MAINTENANCE .....	29
WIRING DIAGRAMS AND PARAMETER TABLES.....	29
BOILER WIRING DIAGRAM.....	30
WIRING DIAGRAM FOR CONNECTING PLANT TYPE 5 (HYBRID) .....	31
STANDARD WARRANTY CONDITIONS .....	32

## INTRODUCTION

### Important safety instructions

Please read these instructions before installing and using the product.

- The appliance's installation and initial start-up must be performed by skilled personnel trained in the relevant safety standards, who are responsible for the definitive installation of the appliance and its efficient operation. KLOVER S.r.l. shall not be held liable if these precautions are not observed.
- During the installation and use of the appliance, all local regulations – including those referring to national and European Standards – must be observed.
- Connect the flue gas outlet to a flue with the specifications described in the "Flue and its connection" section of this User guide.
- The appliance is not suitable for installation on a shared flue system.
- If the flue should catch fire, use appropriate fire extinguishing equipment or call the fire brigade.
- Connect the product to an earthed power socket. Avoid using sockets controlled by switches or automatic timers.
- Do not use the power supply cable if damaged or worn.
- If a multiple socket is used, make sure that the total voltage of the connected devices does not exceed the rated voltage for the socket. Also make sure that the total voltage of all the devices connected to the socket does not exceed the maximum permitted level.
- The plug on the appliance's power cable should be connected only once the assembly and installation of the appliance is complete. It should remain accessible after installation if the appliance is not fitted with a suitable and accessible two-pole switch.
- Do not use flammable substances to clean the appliance or its parts.
- Do not leave flammable containers and substances in the place where the appliance is installed.
- The appliance works exclusively with wood pellets and only with the hearth door shut.
- NEVER open the door of the appliance during normal operation.
- The use of poor-quality pellets or any other material can damage the appliance's operation and void the warranty, resulting in the manufacturer being exempted from all liability.
- Do not use the appliance as an incinerator or for any use other than that for which it was designed.
- Do not use fuels other than those recommended; Do not use liquid fuels.
- The appliance, and its outer surfaces in particular, become very hot to the touch during operation; handle with caution in order to avoid burns.
- Keep fuel and flammable materials at a safe distance.
- Only use original spare parts recommended by the manufacturer.
- Do not make any unauthorised modifications to the appliance.
- Do not touch the hot components of the product (ceramic glass, flue pipe) during normal operation.
- Never touch the appliance if you are barefoot and/or if you have wet or damp parts of the body.
- Use the appropriate button to switch off the electrical panel. Do not disconnect the power supply cable while the appliance is operating.
- During the ignition phase and normal operation of the appliance, maintain the necessary safety distance and do not remain standing in front of it.
- Keep children away from the appliance when it is running since they could get burned by touching its hot components.
- Do not leave the packaging elements within reach of children or unassisted disabled persons.
- Children and inexperienced people must not be allowed to use the appliance; Children must not play with the appliance.
- The appliance may be used by children no younger than 8 years of age and people with reduced physical, sensory or mental capabilities, or those without experience of the appliance, as long as they are supervised or have received instructions on how to use the appliance safely and understand the hazards inherent to the appliance.
- User maintenance and cleaning operations should not be carried out by unsupervised children.
- Do not use the appliance in ways other than those indicated in this user guide.
- The appliance is designed for indoor use only.
- This user guide constitutes an integral part of the appliance. If the product is sold to another user, this manual must be passed on to the new owner.

**Klover declines all liability for accidents deriving from failure to observe the specifications contained in this manual.**

**Moreover, Klover declines any liability arising from improper use of the product by the user, unauthorized modifications and/or repairs, as well as the use of non-original spare parts or parts not suitable for this type of product.**

**Klover shall not be held liable for the product's installation. The installer is the sole party responsible for this operation and is also entrusted with checking the flue, the external air vent and the correctness of the proposed installation solutions.**

**All the safety regulations set out in the specific laws in force in the country where the product is installed must be observed.**

**Non-routine maintenance operations must be carried out only by authorised and qualified personnel.**

**To ensure the validity of the warranty, the user must comply with the instructions contained in this guide and, in particular, must:**

- Use the appliance within its operating limits;
- Regularly perform all maintenance activities;
- Authorise expert and competent people to use the appliance.

**Failure to comply with the instructions contained in this guide shall automatically void the warranty.**

## THE MACHINE AND THE PELLETS

### Components of the appliance

The table below shows the standard features of the appliance:

Expansion vessel	10 l
Safety valve	2.5 bar
Pressure gauge	0 – 4 bar
Automatic air vent valve	Yes
Primary heating circuit circulator pump	Yes. Mod. 25/70
Electrical configuration for the connection of the domestic water flow switch	Yes
Electrical configuration for the boiler / puffer sensor	Yes
Electrical configuration for the control of the optional automatic pellet loader	Yes
Remote control	Optional

The appliance is supplied with the following material:

- 1 User, installation and maintenance manual;
- 1 Power supply cable;

The images below show certain details of the appliance:





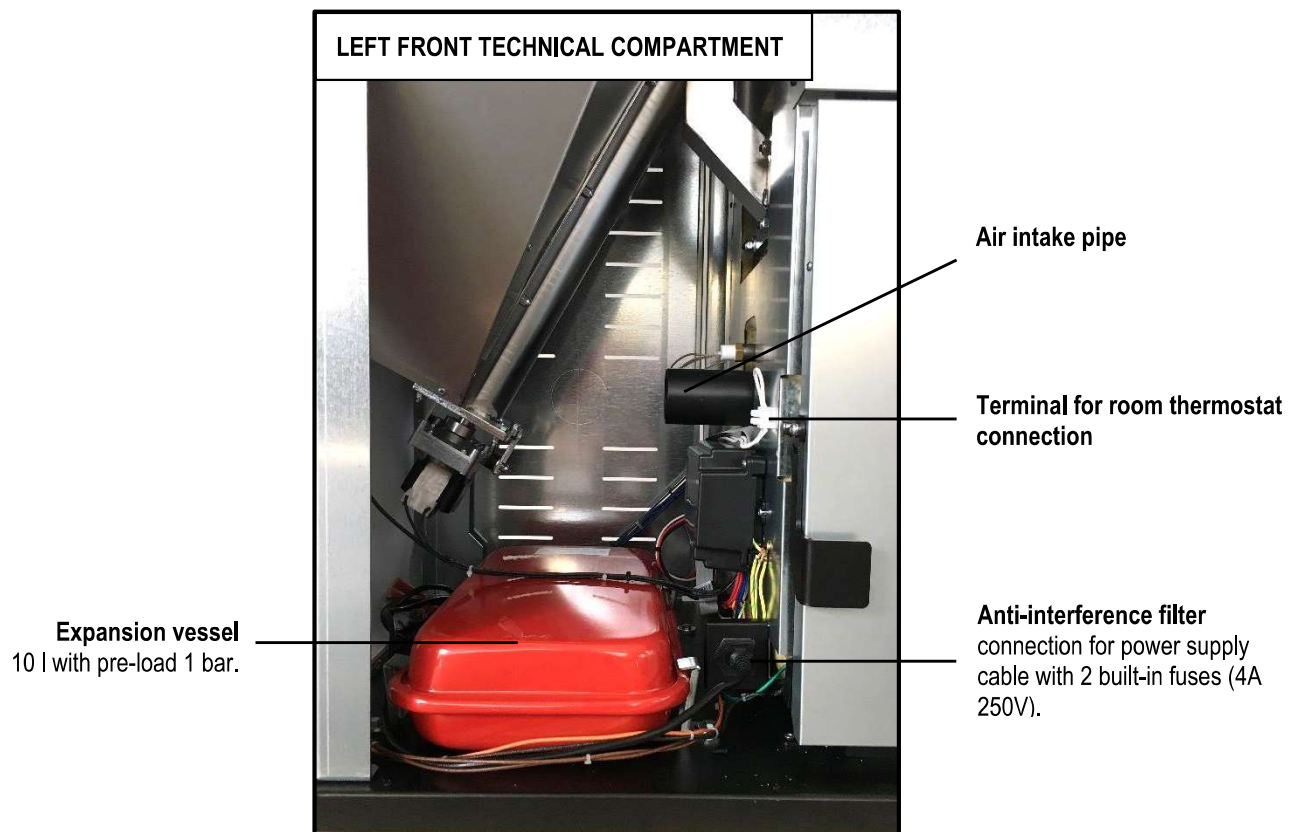

## Technical Specifications

		1	2	3	4	5
		ECOMPACT 190	ECOMPACT 250	ECOMPACT 270	ECOMPACT 290	ECOMPACT 320
Nominal heat input	kW	19.7	25.2	27.4	29.7	32.2
	kcal/h	16,950	21,670	23,560	25,510	27,690
Reduced heat input	kW	4.5	6.5	8.1	8.7	9.4
	kcal/h	3,850	5,590	6,940	7,480	8,080
Nominal heat output	kW	18.2	23.5	25.5	27.5	29.8
	kcal/h	15,650	20,210	21,930	23,650	25,628
Reduced heat output	kW	4.2	6.0	7.5	8.1	8.8
	kcal/h	3,600	5,160	6,460	6,960	7,560
Efficiency at nominal heat output	%	92.3	93.4	93.1	92.7	92.3
Efficiency at reduced heat output	%	93.3	93.1	93.1	93.1	93.1
CO at 10% oxygen at nominal heat output	%	0.010	0.0027	0.0027	0.0027	0.0027
CO at 10% oxygen at reduced heat output	%	0.033	0.0384	0.0387	0.0390	0.0394
Maximum power consumption	Watt	430*	430*	430*	430*	430*
Power consumption during operation at nominal heat output	Watt	63	87	87	87	87
Power consumption during operation at reduced heat output	Watt	35	54	54	54	54
Power consumption in stand-by	Watt	2	3.2	3.2	3.2	3.2
Nominal voltage	V	230	230	230	230	230
Nominal frequency	Hz	50	50	50	50	50
Flue outlet diameter	mm	100	100	100	100	100
Air intake pipe diameter	mm	40	50	50	50	50
Boiler unit capacity	litres	42	52	52	52	52
Pellet tank capacity	kg	55	75	90	75	90
Minimum chimney draught at nominal heat output	Pa	10.0	10.3	9.9	9.4	8.9
Minimum chimney draught at reduced heat output	Pa	6.7	6.6	7.7	8.9	10.2
Combustion gas mass at nominal heat output	g/s	12.3	13.8	14.3	14.9	15.5
Combustion gas mass at reduced heat output	g/s	4.5	6.1	6.5	6.9	7.3
Average exhaust flue gas temperature at nominal heat output	°C	114.0	88.0	90.9	93.7	97.0
Average exhaust flue gas temperature at reduced heat output	°C	85.2	65.4	66.9	68.3	70.0
Minimum safety distance from flammable materials (side/rear/front)	mm	200 / 200 / 800	200 / 200 / 800	200 / 200 / 800	200 / 200 / 800	200 / 200 / 800

\* Power consumption only during the ignition cycle.

The appliance's heat output may vary depending on the type of pellets used.

## Technical sheets for dimensions and connections

All the technical sheets for the dimensions and connections can be viewed by scanning the following QR Code from your smartphone:

1



<https://docs.klover.it/it/guide/help/cs-ec190s-tds-1>

2



<https://docs.klover.it/it/guide/help/cs-ec250s-tds-1>

3



<https://docs.klover.it/it/guide/help/cs-ec270s-tds-1>

4



<https://docs.klover.it/it/guide/help/cs-ec290s-tds-1>

5



<https://docs.klover.it/it/guide/help/cs-ec320s-tds-1>

## Pellet properties

The appliance has been tested with all types of pellets available on the market. The pellets must have the following properties:

- Diameter 6 mm.
- Maximum length 35 mm.
- Maximum humidity content 8 – 9 %.
- 100% wood. Totally additive-free.
- Maximum ash residue 1.1 %.

To obtain good performance from the appliance, we recommend using good quality pellets. **Pellets should be poured into the tank using a shovel, and not directly from the bag.**

Good-quality pellets should have the following properties:

- Constant diameter cylinders with a smooth and shiny surface;
- There should not be a lot of sawdust inside the packaging;
- After grabbing a bunch of pellets and placing them into a container filled with water, good-quality pellets will sink and poor-quality ones will tend to float;
- The quality certification data, in particular conformity to international standards such as EN14961-2, DIN 51731 and O-NORM M7135, should be indicated on the packaging;
- The packages should be intact since pellets tend to absorb humidity. Humidity not only reduces the calorific value and increases the amount of flue gases expelled, but also causes swelling of the product which may create problems with the appliance.

The production of pellets must be compliant with some international standards (such as EN14961-2, DIN 51731 and O-NORM M7135) which establish the minimum values for quality checks on pellets. To facilitate the right choice of the combustible material you can find below one of the most common certification marks identifying the quality of the pellets:

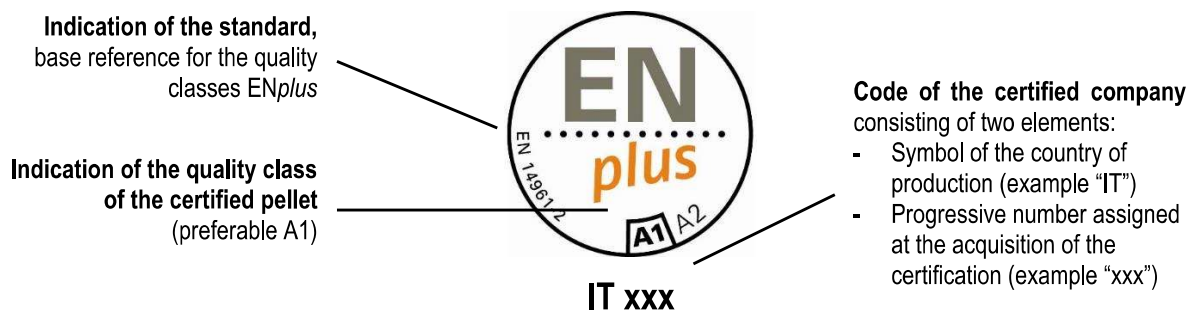

**The use of poor-quality pellets or any other material can damage the appliance operation, voiding the warranty and exempting the manufacturer from all liability.**

**In order to guarantee trouble-free combustion, the pellets must be stored in a dry place.**

## REQUIREMENTS OF THE PLACE OF INSTALLATION

### Positioning

The initial phase for best installation of the appliance is to determine its optimum location; the following elements need to be considered:

- The possibility of creating an external air vent;
- The possibility of creating a straight flue, preferably coaxial to the outlet of the appliance;
- Proximity to the main water drain and/or the boiler (if one already exists);
- Proximity or ease of connection to the water system;
- Ease of access for cleaning the appliance, the flue gas exhaust pipes and the flue.

The unit must be installed on a floor with a suitable load capacity. If the existing building does not fulfil this requirement appropriate measures (e.g. load distribution plate) must be taken.

**The minimum safety distance from flammable materials must be at least 200 mm from the sides and 100 mm from the back of the appliance.** The installation must guarantee easy access for cleaning the appliance, the flue gas exhaust pipes and the flue, and any subsequent maintenance operation by the Authorised technical assistance centre.

Once you have found the best location for the appliance, position it following the instructions given below.

The appliance must not be installed in small rooms, bedrooms, bathrooms or in areas with an explosive atmosphere.

### Spaces around and above the appliance

The figure below shows the minimum distances from walls or other not-easily-removable furniture, that need to be taken into consideration when positioning the appliance.

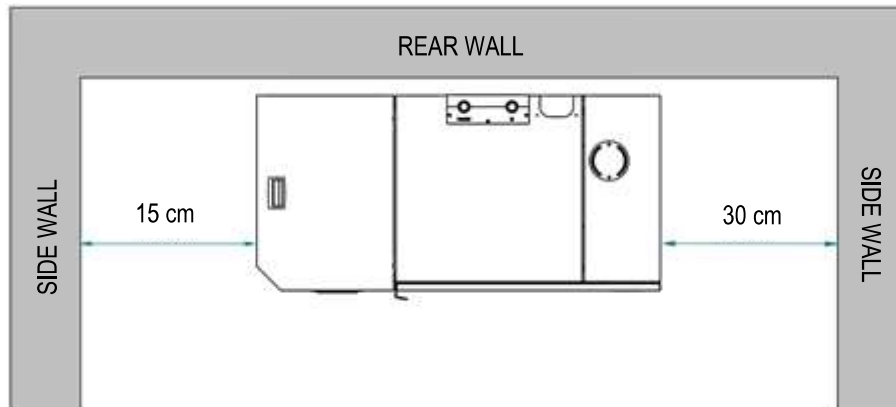

Any shelves or false ceilings mounted above the appliance must be at least 80 cm away from the top part of it.

Furniture and movable objects made from flammable materials must be positioned at least 20 cm from the side surfaces of the appliance; these objects must be moved when performing maintenance on the appliance.

Protect all structures that can catch fire against the radiated heat of the fire.

**Any extra intervention by the Authorised technical assistance centre, which requires the appliance to be disconnected from the system, will not be covered under warranty as described in the chapter “Standard Warranty Conditions”.**

### External air intake

During operation, the appliance takes in air from the environment in which it is installed; It is therefore essential that this air is replaced through an external air vent. The absence of the air vent may affect the flue draught and therefore the combustion and the safety of the appliance.

Therefore, **it is mandatory** to install an external air vent with a minimum completely free passage of **at least 80 cm<sup>2</sup>** (round hole with minimum diameter of 15 cm protected with a special fixed large mesh grille).

If it not possible to put the external air vent in the same room as where the appliance is installed, this hole can be made in an adjoining room as long as this room communicates permanently, by means of a transit hole (15 cm minimum diameter).

The hole must be protected externally with a fixed grille. The protective grille must be checked periodically to ensure that it is not obstructed, thereby impeding the passage of air. **Therefore, keep the air vents clear of obstructions.**

The UNI 10683 Standard FORBIDS the drawing of combustion air from garages, warehouses storing combustible materials, or from business premises with a fire hazard.

If there are other heating or extraction devices inside the room, the air vents must guarantee a sufficient amount of air for properly operating all the devices.

Only sealed appliances (e.g. C type gas appliances, according to the UNI 7129 Standard) or appliances that do not cause a lower pressure compared with the external environment can pre-exist or be installed in the place where the appliance is installed.

Extractor fans can cause malfunctions to the appliance if used in the same room.

### Smoke ducts and connection to the flue

The flue is an essential element for the efficient operation of the appliance. The flue must have the minimum cross-sectional dimensions stated in the appliance's technical specifications (120 mm). Each product must be equipped with its own flue, without other adjoining elements (boilers, chimneys, stoves, etc.). The flue dimensions are closely related to its height, which must be measured from the appliance flue gas outlet to the base of the stack. In order to guarantee adequate draught, the surface of the chimney flue outlet must be double the flue cross-section. The discharge pipe for combustion products generated by the forced draught device, must comply with the following requirements:

- It must seal off the combustion gases, as well as being waterproof and suitably isolated and insulated in relation to the conditions of use (refer to UNI 9615);
- It must be made of suitable materials capable of withstanding normal mechanical stress, heat, and the effects of combustion gases and condensate, if any;
- It must go upwards after the vertical section, for the entire remaining part, with a minimum gradient of 5%. The sub-horizontal section must not be longer than  $\frac{1}{4}$  of the effective height H of the flue or chimney, and **must not be longer than 2,000 mm;**

- It must preferably have a round internal cross-section: square or rectangular cross-sections must have rounded corners with radius not inferior to 20 mm;
- It must have a constant, free and independent internal cross section;
- Rectangular cross-sections must have a maximum ratio of 1.5 between the sides;
- **It must be insulated** to prevent the fumes from cooling and condensate from forming;
- Flue gas pipes (for the section from the appliance to the flue inlet) must be mounted using parts made from non-combustible materials capable of withstanding combustion by-products and their potential condensate (**it is strictly forbidden to use aluminium flues**);
- It is forbidden to use fibre-cement pipes to connect the appliance to the flue;
- Flue gas pipes must not pass through rooms in which the installation of combustion devices is prohibited;
- The flue gas pipes must be assembled in such a way as to guarantee adequate sealing of flue gases when the appliance works in negative-pressure conditions;
- **It is forbidden to install horizontal sections;**
- **It is forbidden to use counter-sloping elements;**
- The flue gas pipe must allow for the recovery of soot or be cleanable, and must have a constant cross-section;
- It is forbidden to allow other air intake pipes and system pipes to transit inside the flue gas pipes, even if they are over-sized.

#### **FURTHER SPECIFICATIONS TO BE CONSIDERED**

- The appliance works with the combustion chamber in negative pressure and the flue pipe under pressure; **it is essential that the flue gas outlet is hermetically sealed.**
- The flue pipes inside the installation room must be made of a suitable material ([see applicable regulations](#)) and equipped with sealing gaskets with a minimum diameter of 120 mm.
- **The pipes must have a double wall (thermally insulated) or be suitably insulated with rock wool. The maximum temperature of the flue pipe inside the room must not exceed 70°C.**
- **IT IS MANDATORY TO HAVE AN INITIAL VERTICAL SECTION OF AT LEAST 0.5 M IN ORDER TO GUARANTEE CORRECT FLUE GAS DISCHARGE.**
- Every direction change must be carried out with a T-shaped fitting and inspection cap. The pipes must be smoketight by means of special seals capable of withstanding temperatures of up to 250°C. Attach the pipes to the wall with special collars to prevent possible vibrations.
- **IT IS STRICTLY FORBIDDEN TO INSTALL DRAUGHT REGULATION VALVES (BUTTERFLY VALVES).**

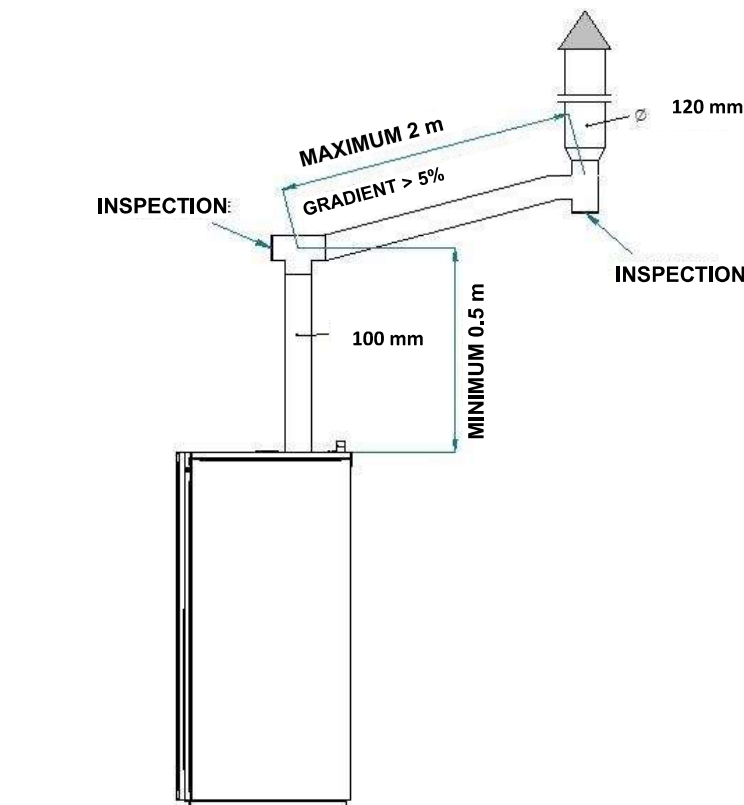

If the flue is old or too large (internal diameter greater than 15 cm), it must be ducted using a stainless steel pipe that is suitably insulated (with rock wool or vermiculite) and sized according to the route. The connection to the flue must be appropriately sealed.

**When assembling the flue, there must be no more than 4 direction changes.**

## Chimney

The **chimney** is a device crowning the flue, used to ease dispersion of combustion products.

It must satisfy the following requirements:

- It must have a usable outlet cross-section which cannot be smaller than double that of the flue onto which it is inserted;
- It must be shaped in such a way as to prevent rainwater or snow from entering the flue;
- It must be built in such a way as to ensure the discharge of combustion by-products even in the event of winds from every direction and inclination.

The outlet height (where height refers to the top of the flue, regardless of any chimney stacks) must be outside of the so-called reflux zone, in order to prevent the formation of counter-pressures preventing the free discharge of combustion by-products into the atmosphere.

It is therefore necessary that the minimum heights - indicated in the following diagrams - are observed:

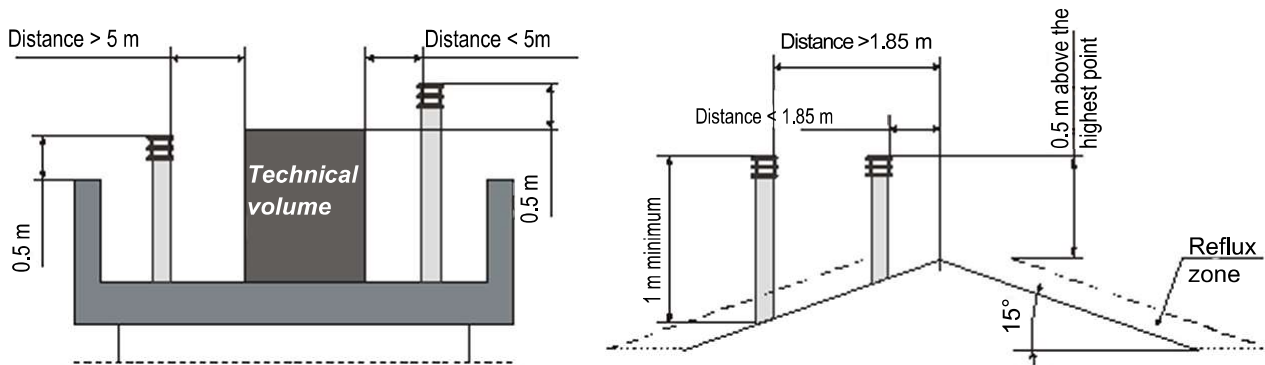



## ELECTRICAL CONNECTION

The electric connection must only be performed by **qualified staff**, in compliance with all general and local safety standards.

**Check that the power supply voltage and frequency correspond to 230 V – 50 Hz.**

The appliance's safety is ensured when it is properly connected to an efficient earthing system.

In the electric connection to the mains power supply, include a 6 A – Id 30 mA differential trip-switch with suitable breaking load. The electric connections, including the earth connection, must be made after shutting off the electrical system.

When completing the system, bear in mind that the cables must be laid in an unmovable manner and far from parts subject to high temperatures. During the final wiring of the circuit, only use components with a suitable electrical protection rating. Do not pass electric cables in the immediate vicinity of the flue gas pipe, unless they are insulated with suitable materials.

**KLOVER S.r.l. declines all responsibility for injury to persons and animals or damage to objects due to failure to connect the appliance to earth or to comply with IEC specifications.**

---

### Control of a possible three-way motorized valve for DHW system management

The pellet appliance is equipped as standard with a control for a possible 3-way motorised valve to be installed on the domestic water circuit based on the selected system type (see "[System configuration](#)"). On the terminal block of the appliance's *left-hand technical compartment* there are four inputs that can be used for controlling this valve (see also "[Wiring diagram](#)"). The four wires connected to the terminal block have different colours, precisely:

- Blue wire = 3-WAY VALVE COMMON (Neutral 230 V)
- Black wire = DOMESTIC WATER SIDE (Live 230 V with DHW demand)
- Brown wire = HEATING SIDE (Live 230 V with no DHW demand)
- Yellow/green wire = GND

---

### Connection to the room thermostat

On the terminal block of the appliance's *left-hand technical compartment* there are two bridged inputs which can be used to connect a room thermostat that will command the operation. The operation of the room thermostat is enabled with plant types 1, 2, 3, 5 (see "[System configuration](#)").

Listed below is the operating principle with **OPEN CONTACT**:

- The appliance switches directly to economy mode operation "*T-AMB ECONOMY*" thus minimising its operating power.
- The heating circulating pump of the appliance switches off.
- The appliance switches off with a delay set to Pr44.

The appliance will switch on again automatically if all of the following conditions occur:

- The contact of the room thermostat closes.
- If it goes below the temperature differential (SET H2O – Pr43).
- Once any cooling cycles are complete.

N.B.: if the water temperature exceeds the set threshold of 80°C (Pr50 = safety temperature), the system's circulator pump is forcedly switched on to ensure the disposal of excessive heat, thus avoiding high water temperatures in the boiler. For this reason, it is recommended that the heating system is not entirely closed.

In the configuration "System type 3", the appliance switches to economy mode and then switches off only if the "*SET BOILER*" temperature setting has been reached.

**WARNING:** if also the external room sensor is enabled, the appliance switches to economy mode if the "*SET ROOM*" temperature setting has also been reached.

## **HYDRAULIC CONNECTION**

The plumbing connections must be made in a rational way using the connections on the template of the appliance. To facilitate connection of the pipes, all plumbing attachments have been fitted to the upper part of the appliance.

The appliance can be coupled with any other boiler already installed on the system. In this case, it is essential to fit all the necessary safety devices and shut-off valves based on the system and intended use. It is also necessary to consider all laws and national, regional, provincial and municipal regulations of the country where the appliance is installed.

The appliance can be installed with the expansion vessel closed because it is equipped with a device for stopping fuel loading, a safety manual reset thermostat and a sound alarm, which are activated if the temperature becomes too high.

**You can install the appliance in the same room as another boiler only if this has a sealed chamber; installation must be performed in compliance with the current regulations.**

**When installing the appliance, it is advisable to fit an anti-condensate mixer valve between the delivery and return pipes on the appliance's heating system. The anti-condensate valve must be calibrated to 55°C with a Kv value equal to or greater than 8 m<sup>3</sup>/h.**

**When connecting the appliance to the system, you should provide a zone that is always open (such as bathroom area) to enable the excess heat dissipation of the water in the body of the boiler.**

The maximum mains water pressure **should never exceed 2.5 bar**; recommended operating pressure is 1.5 bar (with the appliance in operation).

An anti-limescale device must be installed if the water hardness exceeds 28°f. This device must be chosen on the basis of the specific properties of the water.

**TO AVOID COMPROMISING THE OPERATION AND LIFE OF THE HEAT PUMP, WE RECOMMEND INSTALLING A FILTER AND A MAGNETIC DIRT SEPARATOR DOWNSTREAM OF THE RETURN PIPE ON THE APPLIANCE.**

The appliance must be mounted **exclusively** by qualified personnel. Scrupulously comply with the instructions given in this guide.

**The manufacturer declines any liability for damages caused due to incorrect assembly.**

### Hybrid system layout



<https://docs.klover.it/it/guide/help/cs-ecoi-idr-1>



## THE TFT DISPLAY

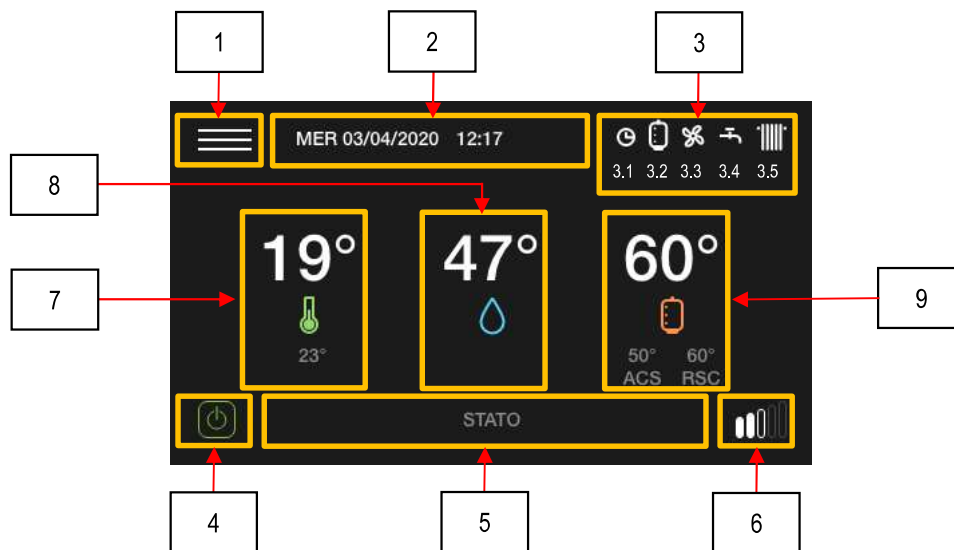

REFERENCE	DESCRIPTION	OPERATION
1	<b>Menu</b>	Button for accessing the menu.
2	<b>Date and time</b>	Shows the set date and time.
3.1	<b>Timer programme</b>	Appears when at least one timer programme is active.
3.2	<b>Puffer demand</b>	Appears when the SET BOILER / SET PUFFER demand is active (request).
3.3	<b>Heat pump</b>	Appears when the heat pump is operating.
3.4	<b>DHW demand</b>	Appears when the DHW flow switch contact input is closed (demand for DHW).
3.5	<b>Space heating demand</b>	Appears when the room thermostat contact input is closed (demand for space heating).
4	<b>ON/OFF</b>	On/off button.
5	<b>Operating status</b>	Shows the operating status.
6	<b>Set power</b>	Allows for accessing the power set-point (SET POWER). - White border = Shows the set power. - White filling = Shows the actual working power (modulation example).
7	<b>Set room</b>	Allows for accessing the SET ROOM set-point (field available only if ROOM SENSOR is enabled) - Top value = Shows the room temperature. - Bottom value = Shows the SET ROOM setting.
8	<b>Water set-point</b>	Allows for accessing SET H2O (field available only with plant type 1, 2, 3) - Top value = Shows the temperature of the water in the boiler. - Bottom value = Shows the SET H2O that has been set or that must be reached by modulation.
9	<b>Set Boiler / Set Puffer</b>	Allows for accessing the SET BOILER / PUFFER (field available only with plant type 3, 4, 5) - Top value = Shows the temperature of the water heater/puffer. - Bottom value = Shows the SET BOILER/PUFFER set-point. - Bottom value DHW = Shows the SET DHW PUFFER set-point. (Plant type 5) - Bottom value HEATING = Shows the SET HEATING PUFFER set-point. (Plant type 5)

## THE MENU - TFT Display

The menu page is divided into various sections that allow for accessing the settings and programming functions of the appliance.

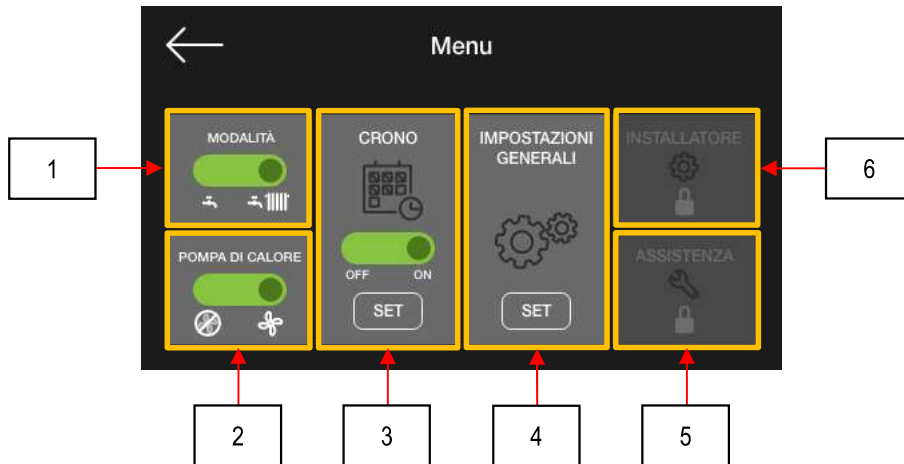

The meanings of the functions present are listed below:

### 1 – SYSTEM MODE

Can only be used with plant type 3 and 5 (refer to the “System configuration” paragraph).

Allows for setting the appliance’s mode of use:

- **DHW** = DHW operation only = Summer mode.
- **DHW / HEAT** = Space heating + DHW operation = Winter mode.

### 2 – HEAT PUMP (appears only with sub-menu “INSTALLER / PLANT TYPE = 5”)

Allows for enabling/disabling the operation consent for the paired heat pump.

- **OFF** = No consent to the heat pump = Pellet-based operation only.
- **ON** = Consent to heat pump = hybrid heat pump + pellet-based operation.

### 3 – SET TIMER

Allows for setting any scheduled operating times.

In the Menu page it can be used to enable and disable all timer-based thermostat functions:

- **OFF** = Any programme set within the schedule is disabled
- **ON** = Any programme set within the schedule is enabled

To ensure correct operation, it should be enabled (“ON”) when at least one on/off programme is activated

Press **SET** to access the programming section.

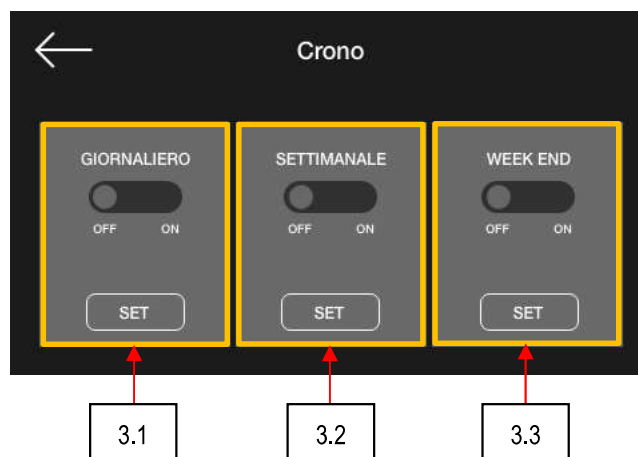

### - Sub-menu 3.1 – DAILY TIMER

Allows for enabling, disabling and setting the DAILY TIMER functions.

In the TIMER page it can be used to enable and disable the programming schedule within it:

- **OFF** = Any programme set within the DAILY TIMER is disabled
- **ON** = Any programme set within the DAILY TIMER is enabled

Press **SET** to access the DAILY TIMER programming section.

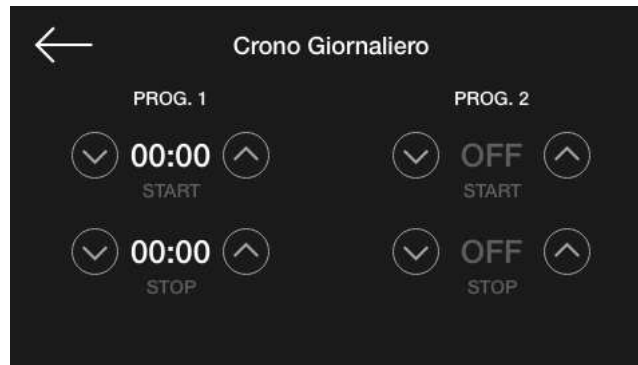

The DAILY TIMER has 2 independent on/off programmes; it is not essential to use them all simultaneously. By setting OFF in the time field, the clock ignores the corresponding command.

### - Sub-menu 3.2 – WEEKLY TIMER

Allows for enabling, disabling and setting the WEEKLY TIMER functions.

In the TIMER page it can be used to enable and disable the programming schedule within it:

- **OFF** = Any programme set within the WEEKLY TIMER is disabled
- **ON** = Any programme set within the WEEKLY TIMER is enabled

Press **SET** to access the WEEKLY TIMER programming section.

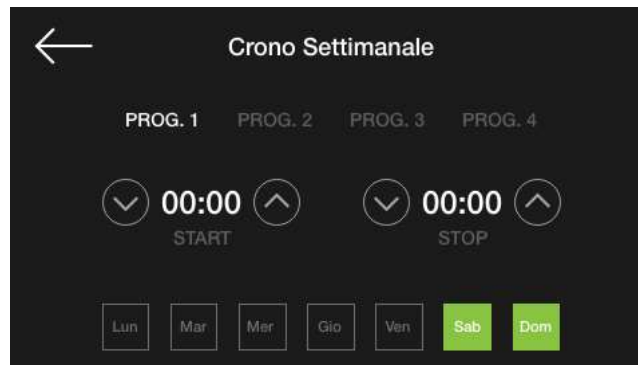

The WEEKLY TIMER has 4 independent on/off programmes; it is not essential to use them all simultaneously. By setting OFF in the time field, the clock ignores the corresponding command.

In setting a programme it is necessary to select the days for which it must be made active.

### - Sub-menu 3.3 – WEEKEND TIMER

Allows for enabling, disabling and setting the WEEKEND TIMER functions (applies to Saturday and Sunday only).

In the TIMER page it can be used to enable and disable the programming schedule within it:

- **OFF** = Any programme set within the WEEKEND TIMER is disabled.
- **ON** = Any programme set within the WEEKEND TIMER is enabled.

Press **SET** to access the WEEKEND TIMER programming section.

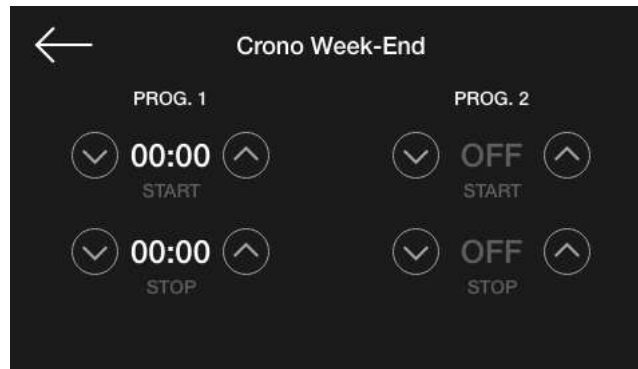

The WEEKEND TIMER has 2 independent on/off programmes; it is not essential to use them all simultaneously. By setting OFF in the time field, the clock ignores the corresponding command.

**TIP:** in order to avoid any undesired switching on/off operations, only activate a single programme at a time (daily, weekly or weekend timer).

Deactivate the daily timer if you wish to use the weekly timer instead. If you use the weekly timer in programmes 1, 2, 3 and 4, always keep the weekend timer disabled.

Only enable weekend timer after disabling the weekly timer.

#### 4 – GENERAL SETTINGS

Allows for accessing the various sub-menus for managing the appliance.

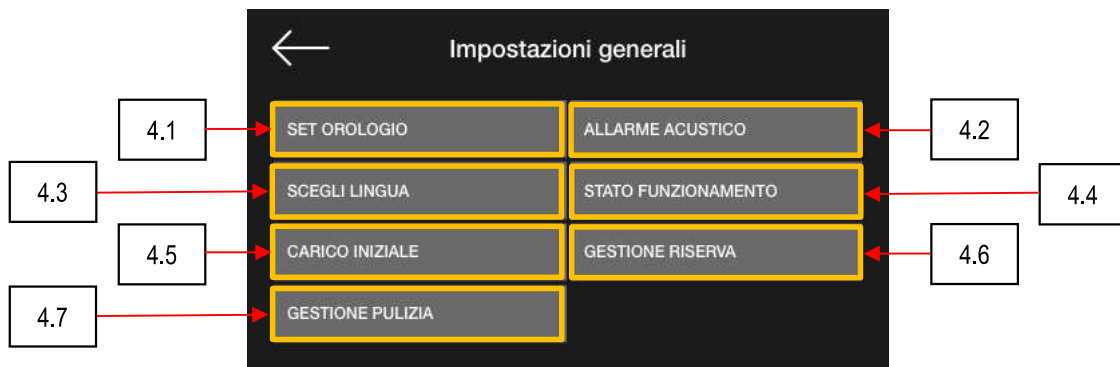

##### - Sub-menu 4.1 – SET CLOCK

Allows for setting the current date and time.

##### - Sub-menu 4.2 – SOUND ALARM

Allows you to enable or disable the acoustic signal in the event of an alarm.

##### - Sub-menu 4.3 – CHOOSE LANGUAGE

Allows you to select the dialogue language from the available options (Italian, English, French, German and Spanish).

##### - Sub-menu 4.4 – OPERATING STATUS

It allows for viewing the instantaneous state of the appliance, by showing the state of the various devices connected to it. Several pages are displayed in succession. The data is reserved for the Technical assistance Centre.

##### - Sub-menu 4.5 – INITIAL LOAD

Enables pellet pre-loading for 180" when the appliance is switched off and has cooled down. Start the function by pressing the **START** button and stop with the **STOP** button. This may be useful if the appliance is switched on after the tank has been completely emptied, or when it is filled for the first time. **Warning: once the operation has been completed, before switching on the appliance you should remove the pellets accumulated inside the brazier.**

### - Sub-menu 4.6 – RESERVE MANAGEMENT

Allows for enabling the sensor for the pellet reserve in the tank and configuring the operation of an automatic loading system (if present) with an auxiliary tank.

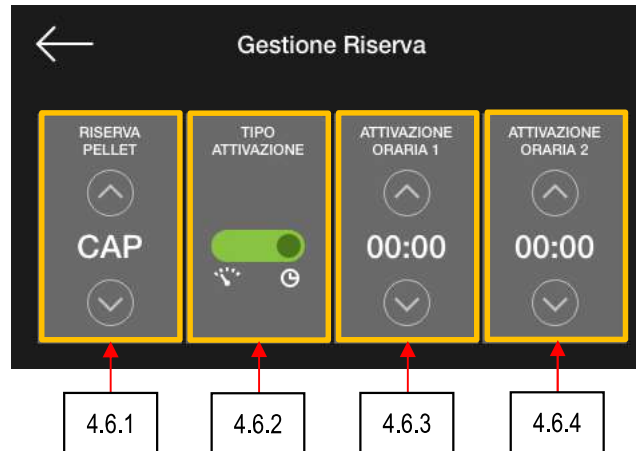

#### o Sub-menu 4.6.1 – PELLETTA RESERVE

Allows for deactivating or selecting the type of pellet reserve sensor mounted on the tank supplied:

- **OFF** = Pellet reserve sensor deactivated.
- **CAP** = Pellet reserve sensor activated. Capacitive-type sensor used (standard).
- **OTT** = Pellet reserve sensor activated. Optical-type sensor used (non-standard).

#### o Sub-menu 4.6.2 – ACTIVATION TYPE

Allows for setting how to control the Vacuum's activation.

- **SENS** = activation with pellet reserve sensor. Whenever the level of pellets in the primary tank falls below the minimum level sensor, the Vacuum function is activated regardless of the time.
- **TIME** = activation at pre-defined time (possibility of switching it on at one or two daily times). Whenever the clock detects the set time, the vacuum activates.

#### o Sub-menu 4.6.3 – TIMED ACTIVATION 1

With 4.6.2 – TYPE OF MANAGEMENT = TIME, it allows for setting the first daily time for the vacuum's activation.

#### o Sub-menu 4.6.4 – TIMED ACTIVATION 2

With 4.6.2 – TYPE OF MANAGEMENT = TIME, it allows for setting the second daily time for the vacuum's activation.

### - Sub-menu 4.7 – CLEANING MANAGEMENT

Allows for calibrating the operation of the automatic cleaner of the smoke chamber.



- **Sub-menu 4.7.1 – ACTIVATION TYPE**  
Allows for setting how to control activation of the smoke chamber cleaner:
  - **ON** = cleaner always active.  
Whenever the appliance is switched on, automatic cleaning of the smoke chamber is activated, regardless of the time.
  - **TIME** = cleaner active with pre-defined time slot.  
Whenever the appliance is switched on within the set time slot (see Sub-menu 4.7.2 – TURBULATORS ON TIME / 4.7.3 – TURBULATORS OFF TIME), the smoke chamber is cleaned automatically. If the appliance is always switched on outside the set time slot, automatic cleaning is carried out at the first available power-on after the time set in Pr144 has elapsed.
- **Sub-menu 4.7.2 – TURBULATORS ON TIME**  
With sub-menu 4.7.1 – ACTIVATION TYPE = TIME it allows for setting the daily start time of the slot within which automatic cleaning is allowed.
- **Sub-menu 4.7.3 – TURBULATORS OFF TIME**  
With sub-menu 4.7.1 – ACTIVATION TYPE = TIME it allows for setting the daily end time of the slot within which automatic cleaning is allowed.

## 5 – INSTALLER CALIBRATIONS

Allows for accessing all data reserved for the system configurations. Access is protected by an access key “P5”.

The menu is reserved for expert users only; access by non-expert users can cause serious damage to the appliance, objects and the environment, as well as personal injuries. Klover declines all responsibility deriving from improper calibration of these values.

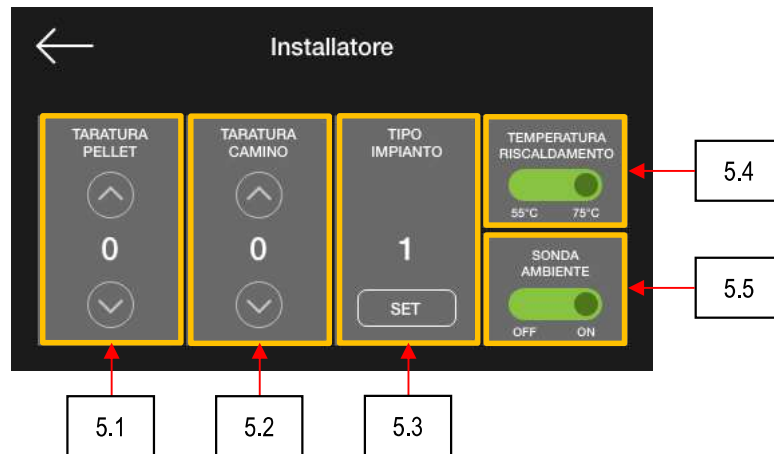

### - Sub-menu 5.1 – PELLETT CALIBRATION

Allows for making a limited calibration of the pellet load in the modes indicated in the following table:

MENU	MEANING	SETTABLE VALUES
<b>PELLET CALIBRATION</b>	By increasing the value by a single unit, the pellet load is increased by about 2%.	-4 / +4
	By reducing the value by a single unit, the pellet load is reduced by about 2%.	

### - Sub-menu 5.2 – CHIMNEY CALIBRATION

Allows for making a limited calibration of the flue gas extractor speed according to the modes indicated in the following table:

MENU	MEANING	SETTABLE VALUES
<b>CHIMNEY CALIBRATION</b>	Increasing the value by a single unit increases the flue-gas extractor speed (and thus the inclusion of combustion air) by roughly 3%.	-4 / +4
	Decreasing the value by a single unit decreases the flue-gas extractor speed (and thus the inclusion of combustion air) by roughly 3%.	

### - Sub-menu 5.3 – PLANT TYPE

Allows for configuring the appliance according to the type of system to which it has been connected to (see “System configuration”).

**- Sub-menu 5.4 – PLANT TEMP.**

Allows for configuring the operating temperature of the heating plant with sub-menu 5.3 – PLANT TYPE = 5:

- **55°C** = Heating plant managed in low-temperature mode.  
(maximum value of SET PUFFER = 55°C)
- **75°C** = Heating plant managed in high-temperature mode.  
(maximum value of SET PUFFER DHW = 55°C / maximum value of SET PUFFER HEAT. = 75°C)

**- Sub-menu 5.5 – ROOM SENSOR**

Enables reading of an optional room sensor (if present) connected to the appliance.

**6 – ASSISTANCE CALIBRATION**

Allows for accessing all data reserved for the Technical Assistance Centre. Access is protected by a password. Unauthorised access can cause serious damage to the equipment, objects and the environment, as well as personal injuries.

## INITIAL START-UP

### System configuration

Before commissioning the appliance, it is advisable to choose which type of system it has been connected to, by accessing "Sub-menu M09-3 – PLANT TYPE".

The available PLANT TYPE configurations are given below:

- **1 = Boiler connected to a heating system and (potentially) an external plate heat exchanger for the production of DHW.**

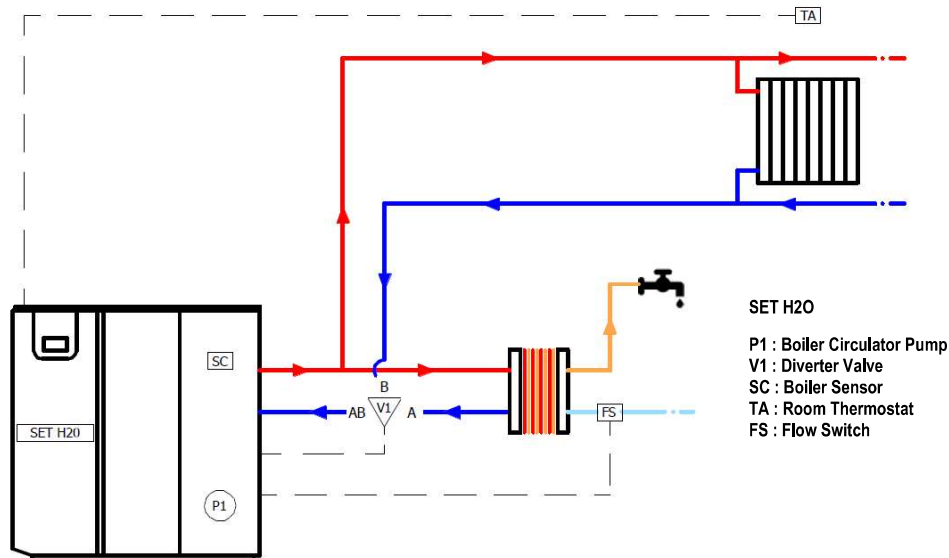

Plant Type "1" involves connecting the boiler to a heating system (or centralised puffer) managed by one or more room thermostats. These are connected to the terminal located inside the appliance's technical compartment. The production of DHW, where required, will be achieved using a plate heat exchanger fitted externally to the appliance and controlled by a flow switch, which is also connected to a terminal arranged on the boiler. This device is used to bring the appliance immediately to domestic hot water power output working mode and to switch a three-way motor-driven valve to give it priority.

- **2 = Boiler with integrated instant DHW, connected to a heating system combined with an alternative DHW generator.**

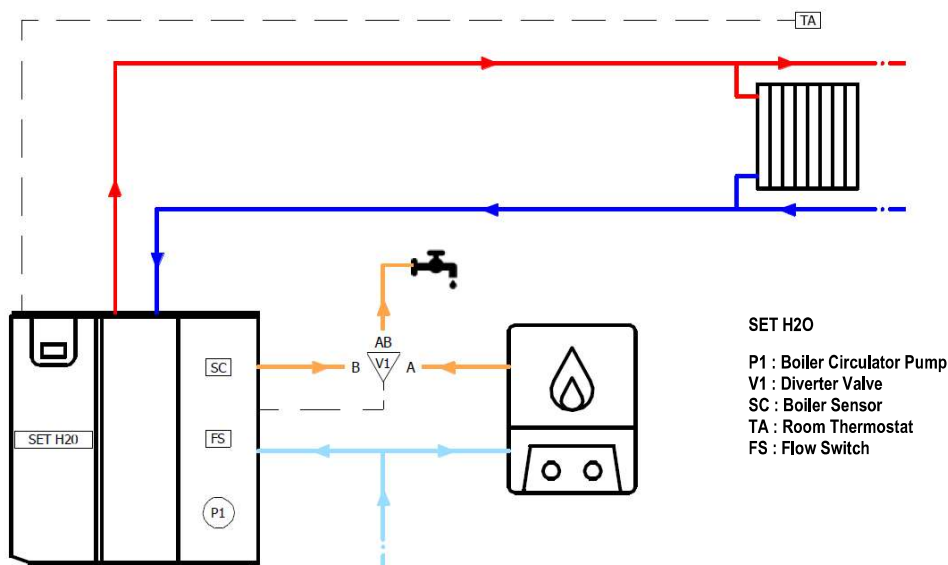

Plant type "2" involves connecting the boiler with integrated instant DHW (configured model only) to a heating system managed by one or more room thermostats. These are connected to the terminal fitted inside the appliance's technical compartment. DHW generation is achieved via a mini storage tank built-into the appliance. To guarantee DHW at all times, in this plant configuration it is necessary to combine an alternative DHW generator. The combination with the alternative DHW generator is managed by a motor-driven three-way valve connected to the pellet-fired appliance: in this way, the DHW generated by the pellet-fired appliance can be used only when the latter is running and has thus reached its working temperature.



➤ **3 = Boiler connected to a heating system and DHW storage water heater.**

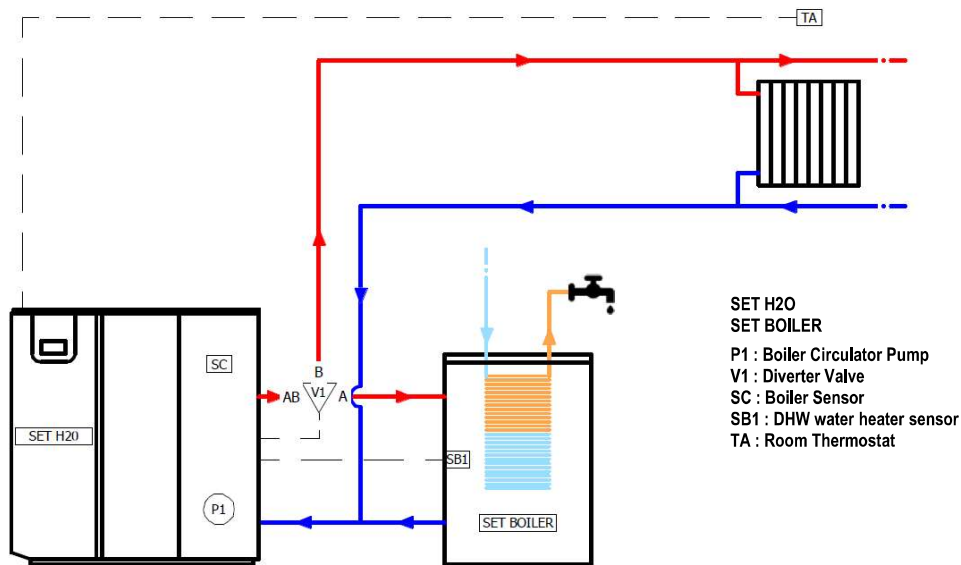

Plant Type “3” involves connecting the boiler to a heating system managed by one or more room thermostats connected to the terminal located inside the appliance’s technical compartment. DHW will be produced by means of a hot water cylinder mounted outside the appliance and controlled by a temperature probe connected to it.

The motor-driven three-way valve – controlled by the pellet-fired appliance – will manage heating of the system or of the hot water cylinder, giving priority to the latter.

Through “Menu 01 – PLANT MODE = DHW” only the hot water cylinder will be managed during summer and the heating system will be left off.

➤ **4 = Boiler connected to a centralised puffer controlled by a H2O sensor connected to it.**

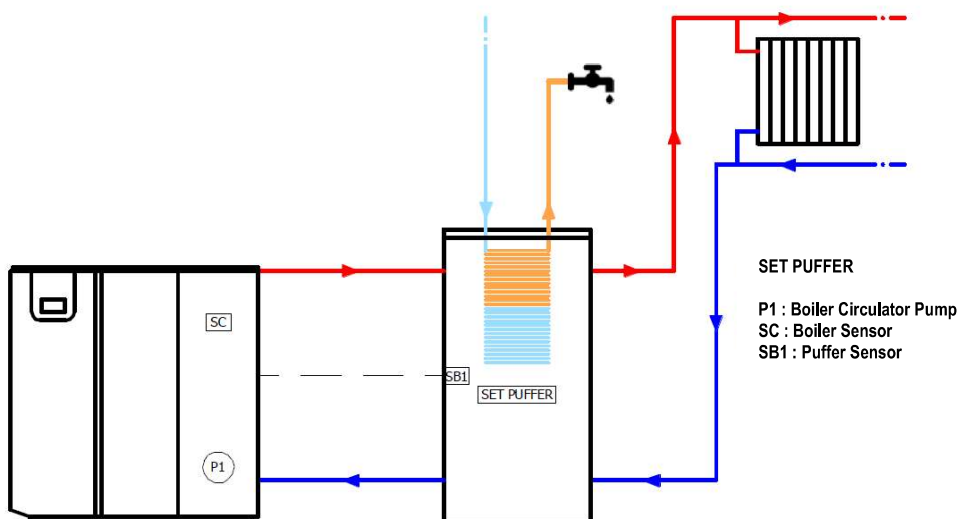

Plant Type “4” involves connecting the boiler to a centralised puffer managed by a temperature sensor connected to the terminal located inside the appliance’s technical compartment. The appliance will operate only at the set temperature of the centralised puffer (“SET PUFFER” which can be set using buttons 1 and 2). This system configuration does not involve any connection of room thermostats or three-way valves to the appliance. These devices will thus have to be managed separately as required.

➤ **5 = Hybrid system = Boiler paired with a heat pump, both connected to a centralised puffer.**

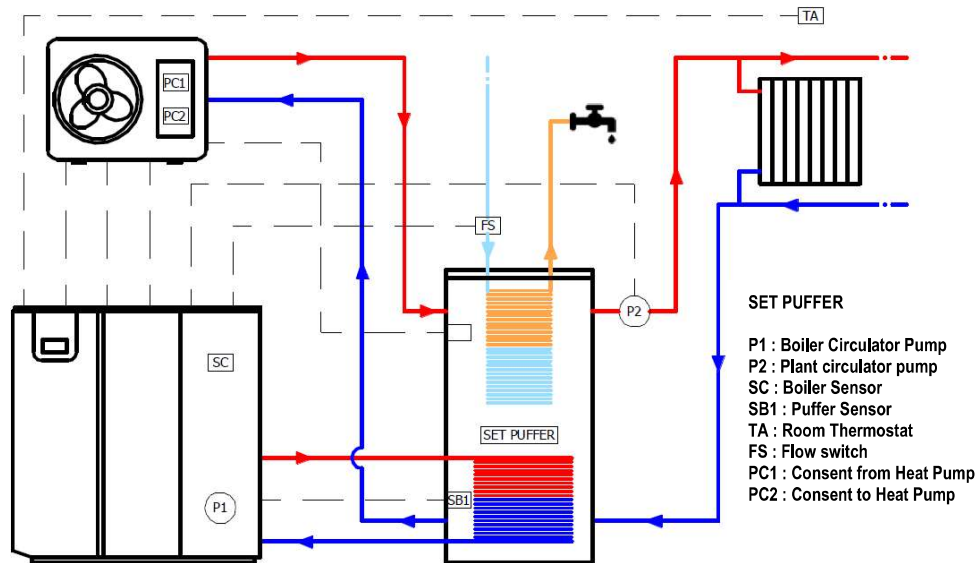

Plant type “5” involves the hybrid operation of the “Boiler / Heat Pump”, both connected to a supplied centralised puffer managed through a temperature sensor connected to the terminal located inside the technical compartment of the boiler and of the heat pump (see “Plant Type 5 layout - hybrid” and “Plant Type 5 wiring diagram - hybrid”).

For the heating system, one or more room thermostats – connected to the relevant terminal inside the boiler’s technical compartment – are connected to the boiler. The boiler controls the consent of the “P2” heating circulator pump on the basis of the room thermostat demand.

DHW is produced by means of a dedicated heat exchanger inside the puffer and managed with a priority demand from the flow switch or temperature sensor, both connected to the terminal block fitted inside the boiler. In the event of a flow switch request, consent to the “P2” heating circulator pump is interrupted and the domestic hot water power is activated on both the boiler and the heat pump.

For operation with a single generator, proceed as follows:

- Operation with **PELLET-FIRED BOILER ONLY**  
Set OFF on the heat pump display or set “Menu 12 – HEAT PUMP = OFF” on the boiler display.
- Operation with **HEAT PUMP ONLY**  
Set OFF on the boiler display and “Menu 12 – HEAT PUMP = ON”. Do not disconnect the power supply to the boiler as the system’s management is guaranteed by the electronics mounted on the boiler itself.

For operation in hybrid mode, by setting ON on the display of both generators (boiler and heat pump), the system will be self-managed in the following modes:

- Space heating system managed with **LOW TEMPERATURE** (Sub-menu M09-5 / 5.4 – SYSTEM TEMP. = 55°C)

SET PUFFER (T. of PUFFER or FLOW SWITCH or THERMOSTAT in demand)	
OUTDOOR T. > 5°C	OUTDOOR T. < 5°C
HEAT PUMP	PELLET-FIRED BOILER

- Space heating system managed with **HIGH TEMPERATURE** (Sub-menu M09-5 / 5.4 – SYSTEM TEMP. = 75°C)

SET DHW PUFFER (T. of PUFFER or FLOW SWITCH in demand)		SET HEATING PUFFER (ROOM THERMOSTAT in demand)	
OUTDOOR T. > 5°C	OUTDOOR T. < 5°C	OUTDOOR T. > 5°C	OUTDOOR T. < 5°C
HEAT PUMP	PELLET-FIRED BOILER	PELLET-FIRED BOILER	PELLET-FIRED BOILER

In case of an alarm, the alternative generator is forcedly started up even in unfavourable conditions.

### Initial filling of the system

After connecting the appliance hydraulically, fill the system as follows:

- Check the tightness of all pipes, the expansion vessel and the circulator pump;
- Open the appliance's "automatic air bleed valve";
- Open the system load cock (mounted on the appliance) to fill the system. Gradually allow the air to come out from the appliance through the "automatic air bleed valve"; the optimum working pressure is 1.5 bar (when the appliance is operating);
- Vent all radiators and any other deaeration systems to ensure that there are no air bubbles in the system.

After installation, check the tightness of all hydraulic joints for the first few days of operation.

The system and the water inside the boiler can be emptied by opening the "boiler body and system drain cock" situated on the right-hand side of the appliance.

**During periods of intense cold it is advisable to leave the heating system running. In the event of a prolonged absence, anti-freeze liquid must be added to the heating water, or the system must be drained completely.**

In a system that is emptied frequently, filling must be carried out with water that has been suitably treated to eliminate its hardness, which can lead to limescale forming.

### Pellet loading and connection to the mains power supply

Perform the following operations:

- Connect the appliance to the electrical system by using the provided cable;
- Set the "power" ON/OFF switch on the front of the appliance to "I" (on);
- Fill the pellet tank; for the first ever start-up, to avoid having to wait for the entire screw feed channel to fill (this operation must be carried out every time the appliance runs out of pellets), we recommend that you follow the instructions in the "Menu 06 – Initial load";
- Switch the appliance on by using the ignition button on the display (button 4). See the instructions below. Warning: before switching on the device make sure that there are no pellets in the brazier; otherwise it is necessary to empty and clean the brazier.

**We recommend that you use high quality pellets so as not to impair the operation of the appliance. Damage caused by poor-quality pellets shall not be covered by the warranty.**

**Do not pour pellets directly into the brazier.**

### Ignition cycle

Pressing button 4 (ON/OFF) for a few seconds allows you to start the ignition cycle. If the system is satisfied, the appliance will go in stand-by "STOP FIRE", otherwise after a few seconds the display will show "START", and the flue gas extractor and spark plug will both switch on. After a few seconds, the appliance enters a pre-load phase "PELLET P-LOAD" during which a continuous supply of pellets is loaded. After the pre-loading phase, the appliance switches to the "WAITING FOR FLAME" phase in which pellets are loaded into the brazier at regular intervals. When the flame is lit, the display shows the message "FIRE ON". This step is used to allow the fire to spread evenly across the brazier and burn all the unburned pellets from the previous phases. After these phases, the appliance enters the work mode at the pre-set power value.

If the ignition fails, the display will show the alarm "NO IGNIT.". **The alarm may also occur if the brazier is dirty; in this case, clean the brazier and re-start.**

#### Summary:

The ignition cycle can last 20/25 minutes max. and is divided into five steps:

- Step 1 - START = Ignition of the flue gas extractor.
- Step 2 - WAITING PREHEATING = Waiting for the plug preheating. (Not as standard settings).
- Step 3 - PELLET P-LOAD = Pellet pre-load (initial continuous load) and plug ignition.
- Step 4 - WAITING FOR FLAME = Loading pellets (intermittent load) and plug operating.
- Step 5 - FIRE ON = Plug switch-off and flame stabilisation.

The appliance switches into working mode after ignition phase at the power output set during ignition via buttons 1 and 2.

**Warning: during the ignition phase and normal operation of the appliance, maintain the necessary safety distance and do not stand in front of it.**

### Switch-off cycle

The appliance switches off if you press button 4 (ON/OFF) during normal operation. The display will show **“FINAL CLEANING”**. The pellet loading stops and the flue gas extractor speed increases to maximum and then switches off after the cooling of the appliance, displaying **“OFF”**.

If button 4 (ON/OFF) is pressed during the ignition cycle, the appliance switches to **“WAITING OFF”** and the appliance will be turned off only at the end of the entire cycle; if, however, button 4 (ON/OFF) is pressed by mistake during this phase, you only need to press it again to delete **“WAITING OFF”**: the appliance will return to normal operation at the end of the entire ignition cycle.

### Modifying the working power and the temperatures of the room, boiler water, water heater or puffer – TFT Display

#### - WORKING POWER

To modify the maximum working power, simply select **“SET POWER”** (Fig. 1) then use the + and – buttons to change the value (Fig. 2).

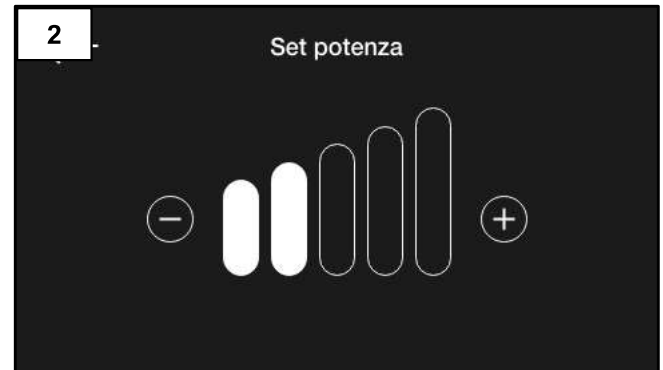

After setting the desired value, confirm by pressing the “back” arrow.

#### - ROOM TEMPERATURE

In plant types 1, 2, 3 and 5, to modify the room temperature simply select the **“SET ROOM”** (Fig. 3) then use the + and – buttons to change the value (Fig. 4).

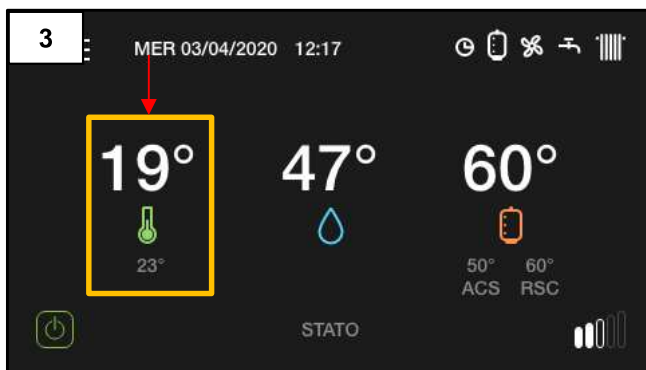

After setting the desired value, confirm by pressing the “back” arrow.

The room temperature setting and thus the **“SET ROOM”** can be accessed only with the room sensor active (Sub-menu 5.5 – ROOM SENSOR = ON).

During the work phase the appliance enters *“Economy mode operation”* when the relevant temperature value is reached; the heating circulator pump is therefore deactivated. The appliance switches off with a delay set to Pr44.

### - BOILER WATER TEMPERATURE

In plant types 1, 2 and 3, to modify the temperature of the water in the boiler (system temperature) simply select “SET H2O” (Fig. 5) then use the + and – buttons to change the value (Fig. 6).

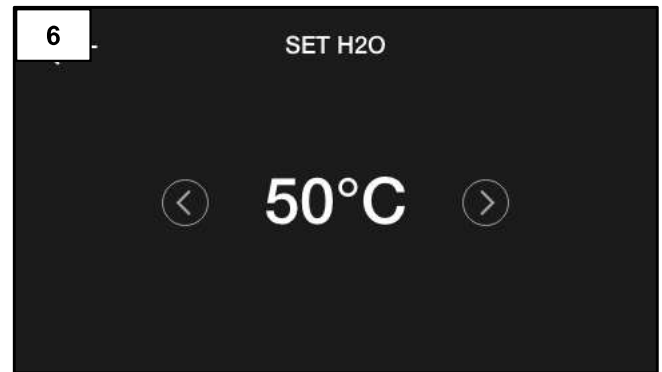
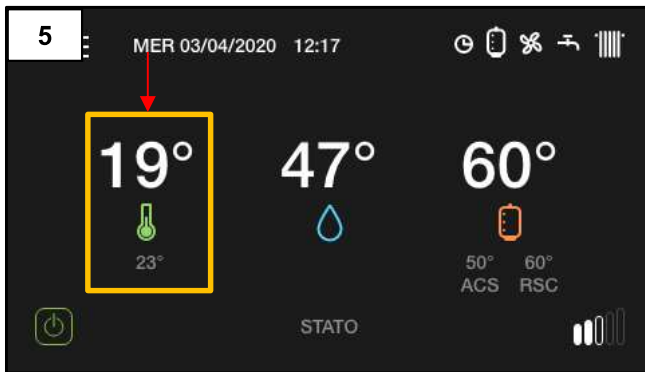

After setting the desired value, confirm by pressing the “back” arrow.

During the working mode the appliance enters “Economy mode operation” when that temperature value is reached.

### - DHW STORAGE CYLINDER TEMPERATURE

In plant type 3, to modify the room temperature simply select the “SET BOILER” (Fig. 7) then use the + and – buttons to change the value (Fig. 8).

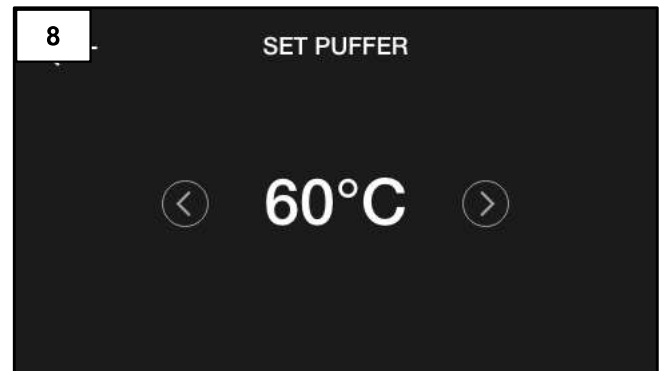
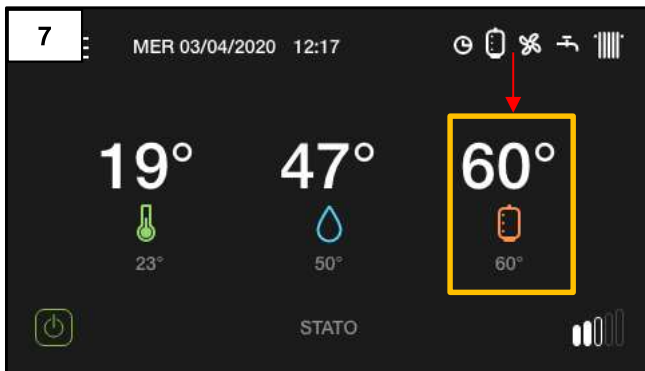

After setting the desired value, confirm by pressing the “back” arrow.

During the working phase, if the boiler is in demand the appliance will switch to “Economy mode” if  $T.H2O > SET\ BOILER + 10^{\circ}C$ .

Below are the operating modes in the event that the “SET BOILER” temperature is reached:

- “Menu 1-SYSTEM MODE = DHW”: the appliance will immediately switch to stand-by “STOP FIRE” mode.
- “Menu 1-SYSTEM MODE = HEAT / DHW”: the motor-driven three-way valve switches to heating mode and the appliance will go into stand-by “STOP FIRE” only if the conditions in the heating system are satisfied.

### - PUFFER TEMPERATURE

In plant types 4 and 5, to modify the puffer temperature simply select “SET PUFFER” (Fig. 9) then use the + and – buttons to change the value (Fig. 10).

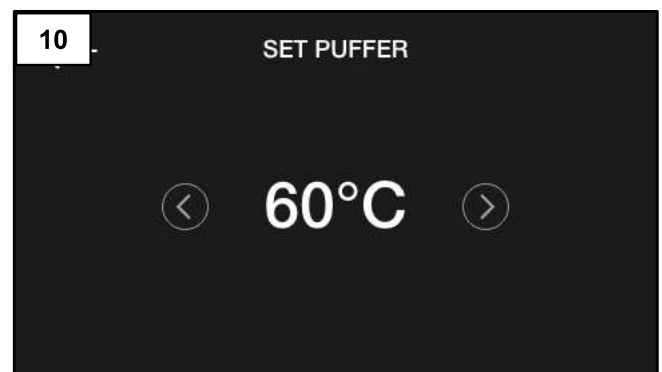

After setting the desired value, confirm by pressing the “back” arrow.

During the working phase the appliance will switch to “Economy mode” if  $T.H2O > SET\ PUFFER + 10^{\circ}C$ .

The appliance will enter the “STOP FIRE” stand-by mode only if the “SET PUFFER” temperature is reached and after a time set through Pr44.

In plant type 5 and with the space heating system managed with high temperature (Sub-menu 5.4 – SYSTEM TEMP. = 75°C), there are two “SET PUFFER” set-points that can be set, using the relevant arrow:

- **SET DOMESTIC HOT WATER [DHW]** = puffer temperature for domestic hot water (Fig. 11).  
(maximum settable value = 55°C)
- **SET HEATING** = Puffer temperature for space heating (Fig. 12).  
(maximum settable value = 75°C)



## PROBLEMS, ALARMS, USEFUL TIPS

### Useful info...

Listed below is some important information regarding the appliance:

- It is normal for the appliance to emit a smell of paint during its first few days of operation. We recommend ventilating the installation room thoroughly during the initial start-up. For the first few days of operation, we also recommend that you set the appliance to near-maximum level.
- The boiler unit is treated with anti-oxidant paint in order to protect it against oxidation in the event of long periods of inactivity. After initial start-up, this paint no longer preserves its original features and any wear of the paint inside the combustion chamber should not be regarded as a manufacturing fault.
- Do not clean with water inside the combustion chamber; any oxidation of the combustion chamber after a long period of inactivity is not to be considered as a manufacturing fault.
- Any perceived noise during operation may be caused by the expansion settling of the plates that make up the boiler unit. These noises are accentuated especially during ignition and switching off phases of the appliance and are not to be considered a manufacturing fault.
- If ignition fails, empty the pellets out of the brazier; only then can you reignite the appliance in order to avoid gasification and consequent “explosion” during ignition which could lead to the breakage of the door glass.
- The appliance works exclusively with wooden pellets; do not burn different fuels.
- The appliance can only work if it is connected to the heating system and with water inside the boiler unit. Do not start the appliance for any reason if it lacks a hydraulic connection made according to the current regulations and unless the entire boiler unit and the system have been filled with water, so as to avoid compromising its life.
- The noise heard during the ignition stage is due to the automatic cleaning of the turbulators.
- The appliance will generate more noise if the pellet container is empty. We therefore recommend always keeping the pellet tank filled to at least half-way.
- If there is soot and fine particulate in the room where the appliance is installed, check the tightness of the flue gas pipes and the filter of the ash vacuum device used for cleaning.
- In the event of overheating, the appliance will switch off when it reaches 85°C.

### What happens if...

#### ...the pellets fail to ignite

If the ignition fails, the display will show the alarm message “NO IGNIT.”.

Cancel the alarm and reset the appliance to standard condition by pressing button 4 for a few seconds.

**If ignition fails, empty the pellets out of the brazier; to avoid gasification, the appliance can only be re-ignited after having emptied the unburnt pellets.**

#### ...the fire door or the pellet container door is open or not properly closed

If the door is left open or not properly closed, the pellet loading will not start, therefore the appliance will not switch itself on. If the door is opened during normal operation, the appliance switches to “THERMAL SAFETY” alarm.

**...the flue pipe is dirty, blocked or not correctly installed**

If the flue is dirty, blocked or not correctly installed, pellet loading will not start, thus the appliance will not switch on. If the flue is obstructed during normal operation, the appliance activates the “*DEPRESS.-FAILURE*” alarm.

**...the appliance is overheated**

If the water in the boiler body is overheated (>94°C), the pellet will not be loaded because the manual reset thermostat cuts in. If this happens during normal operation, the appliance switches to “*THERMAL SAFETY*” alarm. It is therefore necessary to reset the “*manual reset thermostat*” (see “*Components of the appliance*”) before switching the appliance on again. To reset, it is necessary to remove the black cap and press the button below.

**...there is a power outage (blackout)**

If a power blackout occurs for a shorter time than Pr48, when power is restored, the appliance will immediately re-start in the working mode (recovering the set working power).

If the outage lasts longer than Pr48, when power is restored, the appliance will enter the “*STOP FIRE*” (*stand-by*) mode running the entire switch-off cycle until cooling. When this phase is over, the appliance can be restarted resuming work at the set power.

PREVIOUS STATE	BLACKOUT DURATION	STATE AFTER POWER IS RESTORED
OFF	any	OFF
START	duration < Pr48	START
START	duration > Pr48	START
P-LOAD PELLETT	any	BLACKOUT ALARM
WAITING FOR FLAME	any	BLACKOUT ALARM
FIRE ON	duration < Pr48	FIRE ON
FIRE ON	duration > Pr48	STOP FIRE with automatic re-ignition after machine cooling
WORK (any phase)	duration < Pr48	WORK (any phase)
WORK (any phase)	duration > Pr48	STOP FIRE with automatic re-ignition after machine cooling
BRAZIER CLEANING	duration < Pr48	BRAZIER CLEANING
BRAZIER CLEANING	duration > Pr48	STOP FIRE with automatic re-ignition after machine cooling
FINAL CLEANING	duration < Pr48	FINAL CLEANING and after cooling → OFF
FINAL CLEANING	duration > Pr48	FINAL CLEANING and after cooling → OFF
STOP FIRE	any	STOP FIRE

**Alarm signals**

The following table describes the different alarms which may appear.

DISPLAY VISUALISATION	ORIGIN OF ALARM
AL 1 - BLACKOUT ACTIVE ALARM	Blackout alarm. When power is cut off under determined conditions (see “ <i>What happens if...</i> ”)
AL 2 - FLUE GAS PROBE ACTIVE ALARM	Faulty or disconnected flue gas temperature probe.
AL 3 - HOT TEMP ACTIVE ALARM	Flue gas over-temperature. Before displaying the alarm, or when flue gas maximum temperature is reached (Pr14), the display shows “ <i>HOT FLUE GAS</i> ”.
AL 4 - EXTRACTOR-FAILURE ACTIVE ALARM	Faulty flue gas extractor. When the encoder (tachometer) in the extractor detects an extractor speed equal to 0.
AL 5 - NO IGNITION ACTIVE ALARM	No ignition. When the flue gas minimum temperature (Pr13) is not reached within the maximum ignition cycle time (Pr01).
AL 6 - NO PELLETT ACTIVE ALARM	Sudden shut-down during the work phase. When, during the work phase, the flue gas temperature drops below the minimum threshold (Pr28).
AL 7 - THERMAL-SAFETY ACTIVE ALARM	Temperature safety device. When the safety thermostat (water over temperature) or one of the micro switches (contact interrupted) fitted in the fire door or pellet container door cuts in. If the safety thermostat cuts in the boiler stove must be manually rearmed.
AL 8 - DEPRESS.-FAILURE ACTIVE ALARM	Poor depression. When the flue gas pressure switch cuts in (contact interrupted) due to poor draught in the flue pipe.
AL 9 - WATER PROBE ACTIVE ALARM	Faulty or disconnected water temperature probe.
AL c - SF TRIAC ERROR ACTIVE ALARM	Screw feed TRIAC error. When the screw feed gear motor does not stop for at least 0.2 seconds during the maximum work interval of 8.0 seconds. Before the alarm is activated a safety relay cuts in and forcibly cuts off the power supply to the gear motor.

Every alarm causes the appliance to switch-off immediately. The alarm status is reached after the time set on Pr11 (set by default to 60 sec) and can be reset by pressing the ON/OFF button (4).



## CLEANING AND MAINTENANCE

### Precautions before cleaning

Before carrying out any cleaning or maintenance operations, make sure that:

- the appliance is off and has cooled down completely;
- the ash is completely cold.
- the ash vacuum device used for cleaning is suitable and its filter is in good condition.

Before re-starting the appliance, re-install all previously removed components.

During cleaning operations, use the personal protection devices specified in Directive 89/391/EEC.

The frequency for cleaning depends on the type and quality of pellet burnt; therefore, the indicated times may change.

**Any problem affecting the appliance caused by lack of cleaning will not be covered by the warranty. The failure of these operations could affect the safety of the product.**

**Cleaning operations may be carried out by the end user, as indicated in the paragraph below.**

### Routine cleaning

The routine cleaning of the appliance must be done at least every 10 days of operation or after 20 ignition cycles, so as to always guarantee efficient performance and optimal operation. Please proceed as follows:

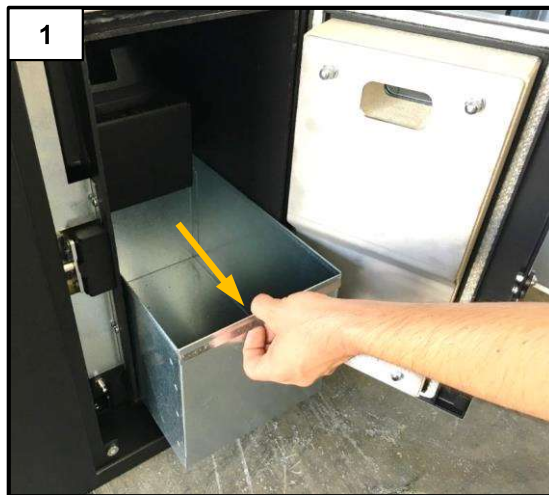

Empty the ash tray (Figure 1).



Thoroughly clean the brazier from combustion residues by taking it out from its position and removing any residues inside (Figure 2). Use a suitable ash vacuum device to remove any ash deposited under the brazier (Figure 3).

To remove any deposits, it is also recommended that you scrape the inner walls of the combustion chamber with a spatula. Do not use tools that can reduce the thickness of the metal sheet of the boiler unit.

**WARNING: use suitable ash vacuum devices equipped with a fine mesh filter in order to prevent ash from being blown into the room and to prevent damaging the vacuum cleaner. We do not recommend the use of normal vacuum cleaners.**



**Non-routine cleaning**

The extraordinary cleaning of the appliance must be done at least every 90 days so as to always guarantee efficient performance and optimal operation. Please proceed as follows:

Perform routine cleaning;

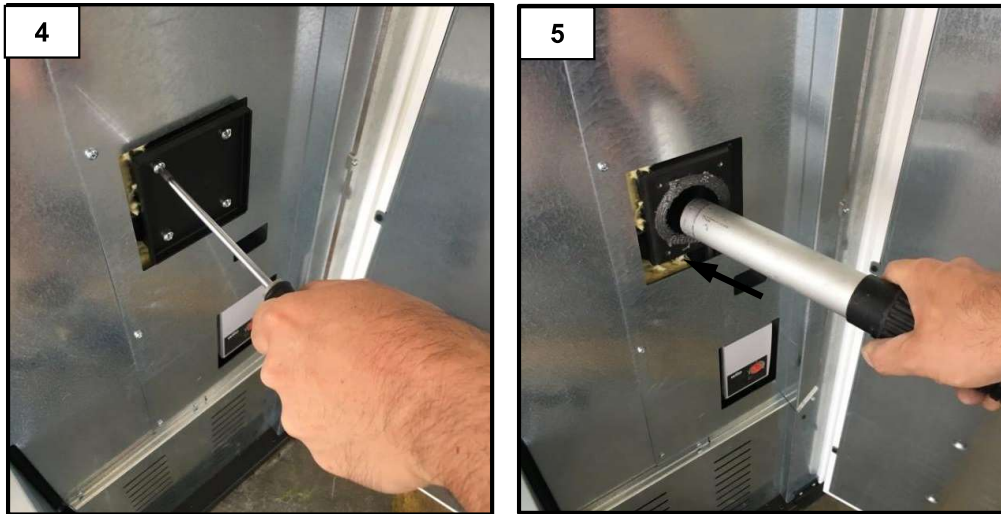

Remove the “extractor smoke chamber front inspection plate” by unscrewing the 4 screws (Figure 4). Using the ash vacuum, vacuum the residues inside it (Figure 5).

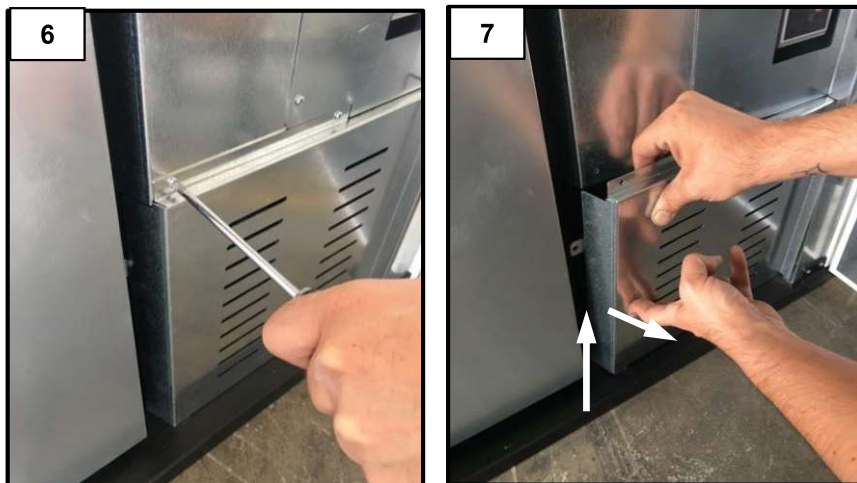

Remove the front guard (Figures 6 and 7).

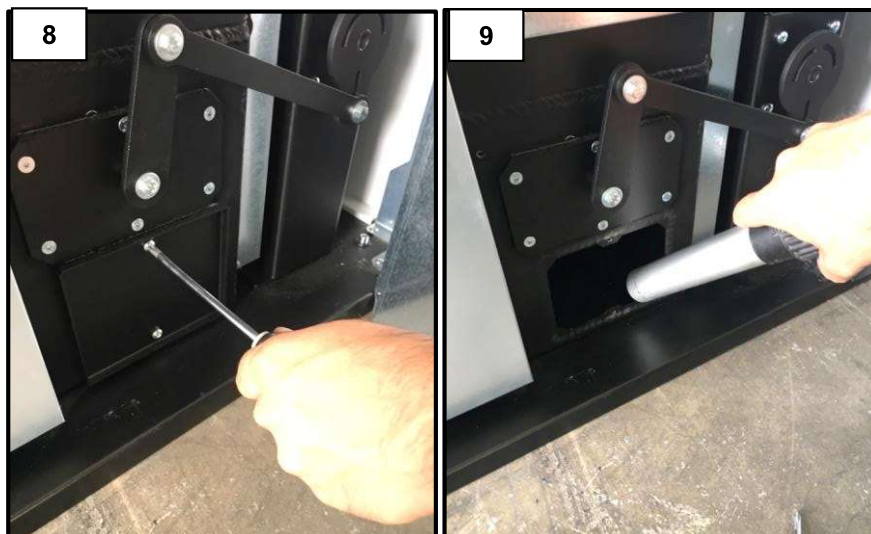

After removing the “turbulator front inspection plate” (Figure 8), vacuum the residues inside it using a suitable ash vacuum device (Figure 9). When finished, replace the plate and front guard.



To ensure correct operation, it is necessary to remove the sawdust deposited on the bottom of the tank (Figure 10) at least once every 30 days. **The pellet tank must be emptied at the end of every season.**

**For improved reliability and efficiency, it is important to clean the pellet level sensor inside the tank, using a soft-bristle brush.**

---

#### Cleaning the ceramic glass

Always clean the glass when the appliance is off and has cooled down completely. Use a damp cloth or a detergent specifically formulated for ceramic glass. Do not use abrasive sponges. Do not clean the glass if still warm; changes in temperature can lead to breakage.

---

#### Cleaning the flue

The flue must be cleaned at least once a year, at the beginning of winter, and nonetheless whenever necessary. *This operation should be carried out by an Authorised Technical Assistance Centre or by a certified chimney sweep.*

It is important to check for any obstructions in the flue before switching the appliance on following long periods of inactivity. If the flue is not cleaned, the operation of the appliance and its components may be compromised.

**The cleaning frequency of the appliance and flue depends on the quality of the pellets used.**

USE TOP-QUALITY PELLETS FOR OPTIMAL RESULTS.

---

#### Maintenance

Timely and systematic maintenance is essential for guaranteeing correct operation, optimal heat performance and durability of the device. Therefore, qualified staff should check the appliance at least once a year at the beginning of the season.

You must periodically check the seals because the latter guarantee the air- and water-tightness of the appliance and its good functioning; if they are worn or damaged you need to replace them immediately by contacting a **Klover Authorised Technical Assistance Centre**.

**For proper operation, the appliance must undergo routine maintenance performed by a Klover Authorised Technical Assistance Centre at least once a year.**

#### WIRING DIAGRAMS AND PARAMETER TABLES

The appliance's wiring diagrams and parameters can be viewed by scanning the following QR Code with your smartphone.

Wiring diagram



[https://docs.klover.it/it/guide/help/cs-sche-I023-8\\_p-1](https://docs.klover.it/it/guide/help/cs-sche-I023-8_p-1)

Parameter tables



<https://docs.klover.it/it/guide/help/cs-ecos-par-1>

**BOILER WIRING DIAGRAM**

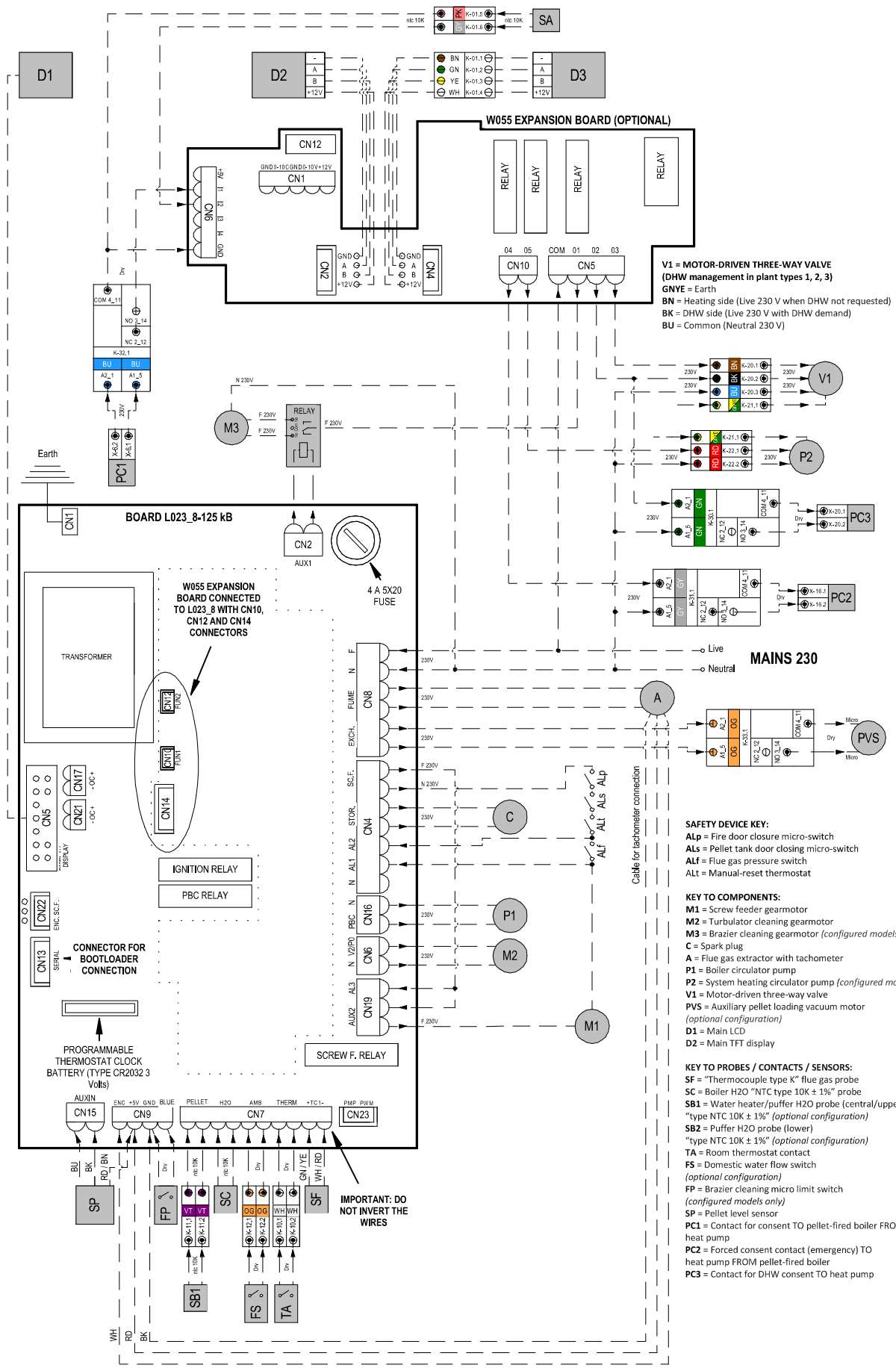

**V1 = MOTOR-DRIVEN THREE-WAY VALVE (DHW management in plant types 1, 2, 3)**  
 GNYE = Earth  
 BN = Heating side (Live 230 V when DHW not requested)  
 BK = DHW side (Live 230 V with DHW demand)  
 BU = Common (Neutral 230 V)

**SAFETY DEVICE KEY:**  
 ALP = Fire door closure micro-switch  
 ALS = Pellet tank door closing micro-switch  
 ALT = Flue gas pressure switch  
 ALT = Manual-reset thermostat

**KEY TO COMPONENTS:**  
 M1 = Screw feeder gearmotor  
 M2 = Turbulator cleaning gearmotor  
 M3 = Brazier cleaning gearmotor (configured models only)  
 C = Spark plug  
 A = Flue gas extractor with tachometer  
 P1 = Boiler circulator pump  
 P2 = System heating circulator pump (configured models only)  
 V1 = Motor-driven three-way valve  
 PVS = Auxiliary pellet loading vacuum motor (optional configuration)  
 D1 = Main LCD  
 D2 = Main TFT display

**KEY TO PROBES / CONTACTS / SENSORS:**  
 SF = "Thermocouple type K" flue gas probe  
 SC = Boiler H2O "NTC type 10K ± 1%" probe  
 SB1 = Water heater/puffer H2O probe (central/upper) "type NTC 10K ± 1%" (optional configuration)  
 SB2 = Puffer H2O probe (lower) "type NTC 10K ± 1%" (optional configuration)  
 TA = Room thermostat contact  
 FS = Domestic water flow switch (optional configuration)  
 FP = Brazier cleaning micro limit switch (configured models only)  
 SP = Pellet level sensor  
 PC1 = Contact for consent TO pellet-fired boiler FROM heat pump  
 PC2 = Forced consent contact (emergency) TO heat pump FROM pellet-fired boiler  
 PC3 = Contact for DHW consent TO heat pump

**IMPORTANT: DO NOT INVERT THE WIRES**

**WIRING DIAGRAM FOR CONNECTING PLANT TYPE 5 (HYBRID)**

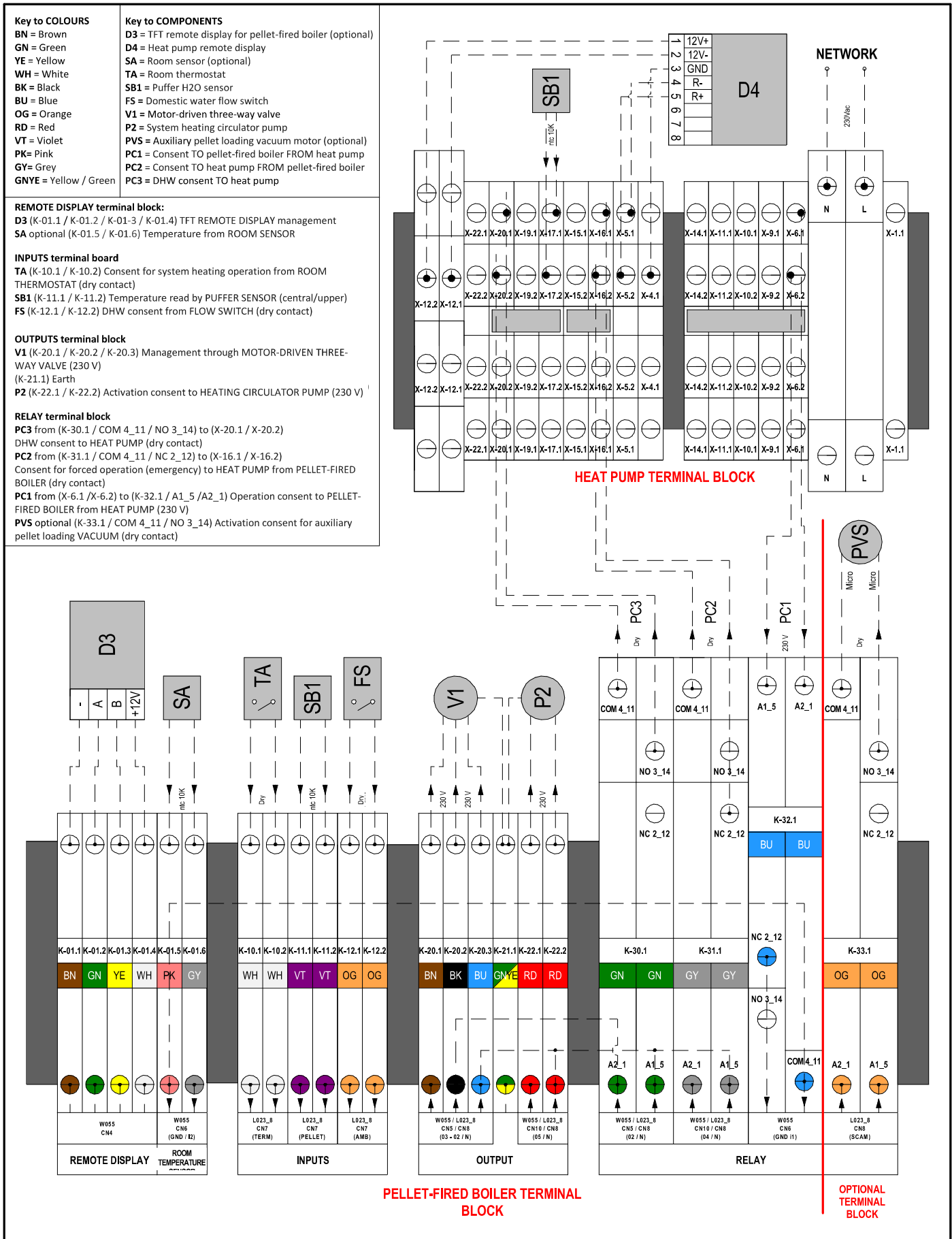



## STANDARD WARRANTY CONDITIONS

### 1. General information

This standard warranty (hereinafter "**Klover Warranty**") is issued by Klover S.r.l., San Bonifacio, Via A. Volta no. 8, for the products shown on the website [www.klover.it](http://www.klover.it) (hereinafter the "**Products**"). The Klover Warranty does not affect the rights provided for by European directive 99/44/EC or by (Italian) Legislative Decree no. 206/2005 "Consumer Code", where applicable. The Klover Warranty is limited to Italy. Klover S.r.l. invites Consumers not based in Italy to contact the dealer from which they bought the Product, to obtain the current warranty conditions.

### 2. Activation of Warranty

In order for it to be valid and effective, the Klover Warranty must be activated within 60 (sixty) days from the date of purchase on the website [www.klover.it](http://www.klover.it), under the "*Register your warranty*" section. Enter the requested data and attach the delivery note or other tax document proving the purchase (e.g. receipt).

Please ensure that the customer's copy of the Warranty Certificate is retained. It must be duly completed and signed by the Consumer and by the installer. The delivery note or other fiscally valid document proving the purchase should also be retained, in order for the Klover Warranty to be valid.

### 3. Two-year Klover Warranty

The Klover Warranty covers the free repair of the Product all parts of the Product that are found to be defective at origin, due to defects confirmed by Klover S.r.l. to be exclusively attributable to the manufacturer. If it is not possible to repair the Product in any way, it will be replaced. In both cases, there will be no change to the expiry or terms of the warranty provided when the Product was purchased.

The Klover Warranty offers all the advantages of a service guaranteed directly by Klover S.r.l. through its network of authorised service centres (*Centri di Assistenza Tecnica* or "**C.A.T.**") in Italy. The list can be found on the website [www.klover.it](http://www.klover.it).

The Klover Warranty will remain in effect for a period of 2 years from the date of purchase, if proven by a delivery note or other proof of purchase (e.g. receipt), stating the name of the seller, the product that was bought, and the date of purchase.

Product components replaced by an authorised dealer at the Consumer's expense as they were "out of warranty" after expiry of the two-year period will be guaranteed by Klover S.r.l. for one year from the date of replacement, excluding costs of intervention, labour and ancillary costs.

### 4. Five-year Klover Warranty

If the initial start-up service is provided by an authorised dealer within 3 months from the date of purchase, the Consumer will be entitled to the Klover Warranty on the "main boiler unit" for a period of 5 years from the date of purchase.

The cost of the initial start-up service is paid by the Consumer.

This Klover Warranty is valid on condition that the seasonal maintenance is performed by the local service centre as indicated in the user manual (for example, Safe Top boiler units require annual use of the Long Life protection).

The Initial Start-Up Report, duly compiled and signed, must be kept carefully to ensure that the Klover Warranty remains operational.

### 5. Complaints and Assistance

As set forth in (Italian) Legislative Decree no. 24/2002, complaints should be sent to the retailer through whom the Product was purchased.

Once the retailer has checked that the Klover Warranty is in force and has not been invalidated, they will contact the local service centre to agree the terms of intervention to verify and eliminate the reported fault. If the Consumer contacts the service centre directly, the service centre must immediately inform the retailer from whom the Product was bought.

If, while inspecting the Product, the service centre finds that the reported defect is not one of the defects covered by the Warranty, the call-out and any works completed, will be paid by the Consumer.

In order to improve the service and reduce intervention time, Consumers are asked to provide the details of the Product they are calling about. In particular, the following information should be provided: • Warranty Certificate number • the name, model and serial number of the Product • the date of purchase • the reported defect.

Klover S.r.l. will not be liable for any delays in carrying out repairs or replacements of the Product.

### 6. Disclaimer

Klover Products must undergo functional testing before any related masonry works are carried out (for example before tiling, installation of pilasters, or painting of the walls). Klover S.r.l. shall not be held liable for any costs incurred as a result of removal and/or reconstruction of related installations, or for any other ancillary intervention even if it is the result of works to replace defective parts.

Klover S.r.l. shall not be held liable for any faults in the Product that may be attributable to external conditions and/or events, including but not limited to insufficient installation capacity, incorrect installation, lack of maintenance or maintenance not carried out according to the instructions in the user manual, or misuse of the Product. The cost of any works will be paid by the Consumer in such cases.

Klover S.r.l. declines all liability in respect of any loss or damage that may be caused directly or indirectly to the Consumer and/or to a third party or to persons, animals or property as a result of failure to comply with all the relevant instructions concerning installation, use and maintenance of the Product. The injured party must prove the loss or damage, the defect, and the causal connection, and inform the retailer from which the Product was purchased, in accordance with (Italian) Legislative Decree no. 24/2002.

### 7. Exclusions from Klover Warranty

The Klover Warranty does not include:

- Product defects not ascribable to manufacturing defects
- Product defects not related to incorrect or inappropriate installation
- Defects related to improper functioning of the chimney flue
- Product defects caused by negligence, accidental breakage, normal wear and tear, tampering and/or damage during transport (scratches, dents etc.), including shipments sent free to destination, works carried out by unauthorised personnel, and additional damage caused by inappropriate intervention by the Consumer
- Calibration of parameters
- Damage caused by the use of expired or inappropriate fuel
- Transport costs.

The Klover Warranty excludes the following Product components:

- Ceramic or tempered glass, ceramic/majolica tiling and/or lacquered steel and/or cast iron. Changes in colour shades, speckling, superficial cracking, shading and minor dimensional variations are not considered Product defects, but are characteristics of the artisanal manufacturing process
- Painted, chromed or gilded details, handles, dials
- All the external components of the Product on which the Consumer may intervene directly during use and/or maintenance, or which may be subject to wear and tear and/or the formation of rust, or blemishes on the steel caused by harsh detergents, in particular the use of wood at a rate that exceeds the recommended hourly capacity, or the use of fuels that were not recommended or were not included in the instructions
- Refractory materials or vermiculite
- The pellet brazier, grille and cast iron cooking plate, the smoke deflector or flame guard, the seals, fuses or batteries in the Product's electronic components and any other removable component that may be subject to normal wear and tear
- Electrical and electronic parts found to be faulty as a result of non-standard electrical connections, natural disasters or voltage variations other than the nominal variation.

### 8. Competent court

Any disputes shall be settled exclusively by the Court of Verona.







KLOVER S.R.L.

Via A. Volta, 8

37047 San Bonifacio (VR), Italy

VAT Reg. No. 02324280235

[www.klover.it](http://www.klover.it)